



## Features

- 2,000 counts manual type DMM with LCD display
- 100L LQFP package
- 3V DC power supply
- Fast ADC Conversion rate : 4 times/s for V/R modes
- Manual type measurement
  - \* Voltage measurement :  
200mV/ 2V/20V/200V/ 1000V
  - \* Current measurement :  
20.00u/200.0u/2000u/20.00m/200.0m/20A
  - \* Resistance measurement :  
200/2k/20k/200k/2M/ 20M/200MΩ
  - \* Capacitance measurement:  
2n/20n/200n/2u/20u/200u/2m/20mF
  - \* Not contact AC electric field detection
  - \* Diode voltage measurement
  - \* Continuity check
- Auto frequency measurement mode  
200.0Hz ~ 20.00MHz auto range
- Hazardous AC/DC voltage (HV) indication
- 4 ADP modes for extension application
- Temperature mode with internal scale translation circuit from °C to °F (1°C resolution)
- K-type thermocouple reference table compensation (-200 ~ 1350°C range)
- Push functions :
  - \* MAX/MIN
  - \* KEY function (AC/DC or °C/°F swap)
  - \* Data Hold & Backlight function

- Band-gap reference voltage output
- Current mode overflow selection
- Voltage mode overflow selection  
( DC / AC : 1010V, DC / AC : 610V)
- LCD segment check when power on
- Auto power off ( 30min idle time )
- Sleep state indicative signal output
- Re-power on
- On-chip buzzer driver
- Low battery detection

## ■ Description

ES218 is an integrated analog-to-digital converter with 2,000-count LCD, manual type DMM IC which is operated 3V DC power supply. Automatic range selection is provided for frequency measurement only. It could support AC/DC voltage measurement, resistance measurement, capacitance measurement, and AC/DC current measurement. Expensive and bulky mechanical range switches are not required. Other features include data holding, maximum and minimum value holding, diode measurement, temperature measurement, continuity checking, low battery detection, auto power off, re-power on, backlight driver and buzzer driver.

## Application

- Manual type digital multimeter
- Manual type digital clamp meter



Pin Assignment

- 100L LQFP package

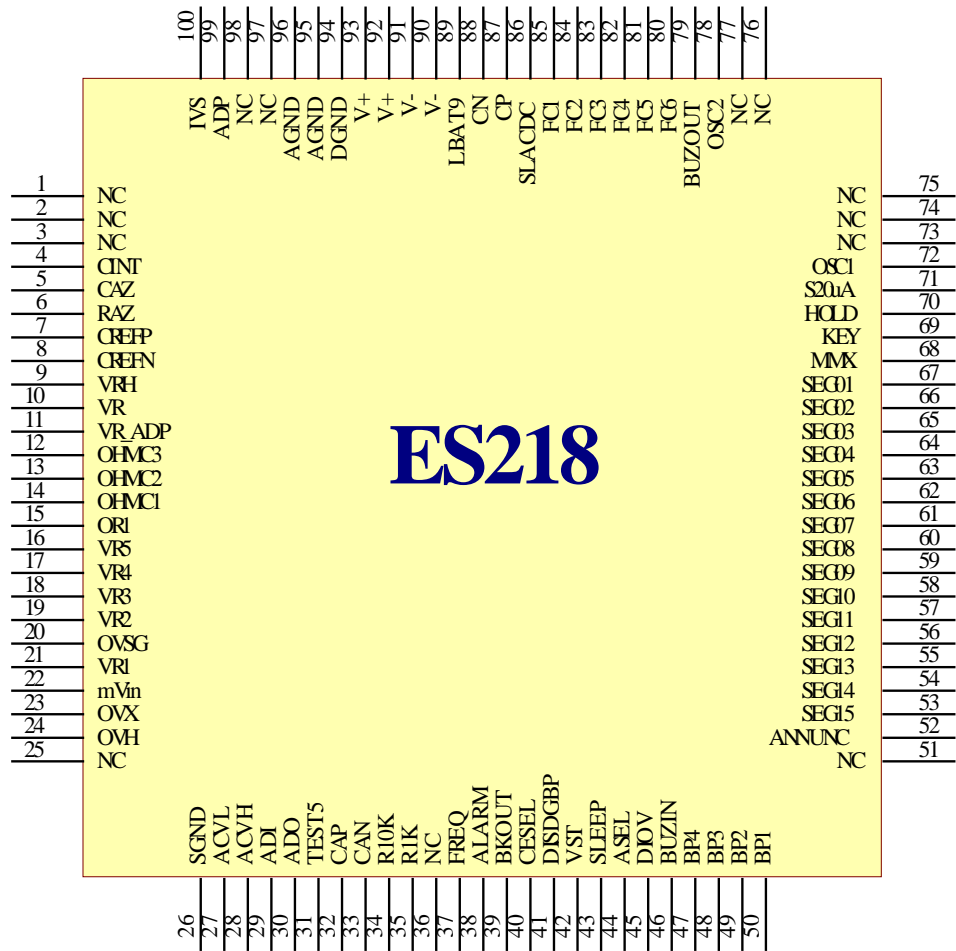



**Pin Description**

Pin No	Symbol	Type	Description
1-3	NC	-	Not Connected.
4	CINT	O	High-resolution integrator output. Connect to integrate capacitor. (Metalized Polypropylene Film Capacitor type is recommended)
5	CAZ	O	High-resolution auto-zero capacitor connection.
6	RAZ	O	Buffer output pin in AZ and ZI phase.
7	CREFP	O	Positive connection for reference capacitor of A/D.
8	CREFN	O	Negative connection for reference capacitor of A/D.
9	VRH	O	Output of band-gap voltage reference. Typically -1.23V.
10	VR	I	Reference input voltage connection. Typically -400mV.
11	VR_ADP	I	Reference input voltage connection. Typically -400 mV.
12	OHMC3	O	Filter capacitor connection for resistance mode.
13	OHMC2	O	Filter capacitor connection for resistance mode.
14	OHMC1	O	Filter capacitor connection for resistance mode.
15	OR1	O	Reference resistor connection for 200.0Ω range
16	VR5	O	Voltage measurement ÷10000 attenuator(1000V)
17	VR4	O	Voltage measurement ÷1000 attenuator(200.0V)
18	VR3	O	Voltage measurement ÷100 attenuator(20.00V)
19	VR2	O	Voltage measurement ÷10 attenuator(2.000V)
20	OVSG	O	Sense low voltage for resistance/voltage measurement
21	VR1	I	Voltage measurement Input. Connect to an accurate 10MΩ resistor.
22	mVin	I	Measurement input in 200.0mV mode.
23	OVX	I	Sense input for resistance / capacitance measurement.
24	OVH	O	Output connection for resistance measurement.
25	NC	-	Not Connected.
26	SGND	I	Signal Ground input.
27	ACVL	I	Rectified signal low input in ACV/ACA mode. Connect to negative output of external AC to DC converter.
28	ACVH	I	Rectified signal high input in ACV/ACA mode. Connect to positive output of external AC to DC converter.
29	ADI	I	Negative input of internal AC to DC OP Amp.
30	ADO	O	Output of internal AC to DC OP Amp.
31	TEST5	O	Buffer output of OVSG.
32	CAP	O	Positive auto-zero capacitor connection for capacitor measurement.
33	CAN	O	Negative auto-zero capacitor connection for capacitor measurement.
34	R10K	O	Connect to a precise 10KΩ resistor for capacitor measurement.
35	R1K	O	Connect to a precise 1KΩ resistor for capacitor measurement.
36	NC	-	No connection
37	FREQ	I	Frequency counter input, offset V-/2 internally by the chip.
38	ALARM	O	HV signal detection in Voltage mode and EF mode indication output.



**Pin Description ( Continued )**

Pin No	Symbol	Type	Description
39	BKOUT	O	Push Hold key lager than 2 sec. to enable the back light function. This pin will change from V- to V+ and lasts for 5 minutes.. Once press Hold key lager than 1 sec. again , this pin will change level back to V-.
40	CESEL	I	Voltage OL selection feature control pin. (1010V/610V)
41	DISDGBP	I	Control warning buzzer output at HV mode. Pulled to low and buzzer is disabled.
42	VST	I	In $\mu$ A or mA modes, it is used to control the 'μ' or 'm' sign. Set to V- to enable clamp current mode. The initial voltage range will be set to 200.0V range also.
43	SLEEP	O	Sleep mode indicator, asserts low in SLEEP mode.
44	ASEL	I	Current mode OL indication for 2000A (VST = V-) or 20A (VST = Floating) ranges
45	DIOV	I	Pulled to V- to set the 2.8V OL level in diode mode measurement
46	BUZIN	I	Pulled to V- to enable the buzzer output (BUZOUT) always.
47-50	BP4-1	O	LCD backplane 4 - LCD backplane 1
51	NC	-	Not connected
52	ANNUNC	O	Square wave output at the backplane frequency, synchronized to BP1. ANNUNC can be used to control display annunciator. Connect a LCD segment to ANNUNC to turn it on; connect an LCD segment to its backplane to turn it off.
53-67	SEG15 - SEG01	O	LCD segment line 01 – 14.
68	MMX	I	Pulse to V- to enable MAX/MIN function.
69	KEY	I	Pulse to V- to change mode.
70	HOLD	I	Pulse to V- less than 1 second. to enable HOLD function.
71	S20uA	I	Pulled to V- to change 200.0uA to 20.00uA display
72	OSC1	-	Connect to 4MHz crystal oscillator
73-77	NC	-	Not connected
78	OSC2		Connect to 4MHz crystal oscillator
79	BUZOUT	O	Outputs a 2KHz audio frequency signal for driving piezoelectric buzzer
80	FC6	I	Switch 6 for function selection.
81	FC5	I	Switch 5 for function selection.
82	FC4	I	Switch 4 for function selection.
83	FC3	I	Switch 3 for function selection.
84	FC2	I	Switch 2 for function selection.
85	FC1	I	Switch 1 for function selection.
86	SLACDC	I	Select initial DC/AC state.
87	CP	O	Positive capacitor connection for on-chip DC-DC converter.
88	CN	O	Negative capacitor connection for on-chip DC-DC converter.



**Pin Description ( Continued )**

Pin No	Symbol	Type	Description
89	LBAT9	I	Low battery configuration. If 3V battery is used, connect it to DGND. The default low-battery threshold voltage is -2.3V. If 9V battery is used, the low battery enunciator is displayed when the voltage of this pin is less than VRH (-1.2V)
90	V-	P	Negative supply voltage.
91	V-	P	Negative supply voltage.
92	V+	O/P	Output of on-chip DC-DC converter.
93	V+	O/P	Output of on-chip DC-DC converter.
94	DGND	P / G	Digital ground.
95	AGND	P / G	Analog ground.
96	AGND	P / G	Analog ground.
97-98	NC	-	Not connected
99	ADP	I	Measurement input in ADP/Temp mode.
100	IVS	I	Measurement input in uA/mA/A current mode.



### Absolute Maximum Ratings

Characteristic	Rating
Supply Voltage (V- to AGND)	-4V
Analog Input Voltage	V- -0.6 to V+ +0.6
V+	V+ ≥ (AGND/DGND+0.5V)
AGND/DGND	AGND/DGND ≥ (V- -0.5V)
Digital Input	V- -0.6 to DGND +0.6
Power Dissipation. Flat Package	500mW
Operating Temperature	-20°C to 70°C
Storage Temperature	-45°C to 125°C

### Electrical Characteristics

T<sub>A</sub>=23°C

Parameter	Symbol	Test Condition	Min.	Typ.	Max	Units
Power supply	V-		2.4	-3.0	3.3	V
Operating supply current In DCV mode	I <sub>DD</sub>	Normal operation	—	1.8	2.2	mA
	I <sub>SS</sub>	In sleep mode	—	—	10	μA
Voltage roll-over error	REV	10MΩ input resistor	—	—	±0.1	%F.S <sup>1</sup>
Voltage nonlinearity	NLV	Best case straight line CIL=MPR capacitor	—	—	±0.1	%F.S <sup>1</sup>
Zero input reading		10MΩ input resistor	-000	000	+000	counts
Band-gap reference voltage	V <sub>REF</sub>	100KΩ resistor between VRH and AGND	-1.30	-1.23	-1.16	V
Open circuit voltage for 400Ω measurement		V=-3V	—	-3.0	—	V
Open circuit voltage for other Ω measurement			-1.19	-1.08	-0.97	V
Peak to peak backplane voltage	V <sub>LCD</sub>	-3.5V ≤ V- ≤ -2.2V	3.0	3.1	3.2	V
Low battery flag voltage		V- to AGND (LBAT9 connected to GND)	-2.4	-2.3	-2.2	V
Internal pull-high to 0V current		Between V- pin and HOLD, KEY, FC1-FC6, MMX	—	1.2	—	μA
AC frequency response at 2.000V range		±1%	—	40-400	—	HZ
		±5% (No compensated)	—	400-2000	—	
Capacitance measurement accuracy		2nF – 200uF	-2.5	—	2.5	%
			-3	—	3	counts
Capacitance measurement accuracy		2mF – 20mF	-3.5	—	3.5	%
			5	—	5	counts
Reference voltage temperature coefficient	TC <sub>RF</sub>	-20°C < T <sub>A</sub> < 70°C	—	100	—	ppm/°C

Note:

1. Full Scale.



## Function Description

### 1. Operating Modes

#### 1.1. Voltage Measurement

A re-configurable voltage divider provides a manual range in voltage measurement mode. The 200.0mV range is independent and manual mode. It takes input signal from *mVin* (pin22). The other ranges take the input signal from *VR1* (pin21). The following table summarizes the Full-Scale ranges in each configuration.

Configuration	Full Scale Range	Divider Ratio	Resister Connection	Input Pin
<b>VR1</b>	200.0mV	1	-	<i>mVin</i> V.S. <i>SGND</i>
<b>VR2</b>	2.000V	1/10	VR2 (1.111MΩ)	<i>VR1</i> V.S. <i>SGND</i>
<b>VR3</b>	20.00V	1/100	VR3 (101KΩ)	<i>VR1</i> V.S. <i>SGND</i>
<b>VR4</b>	200.0V	1/1000	VR4 (10.01KΩ)	<i>VR1</i> V.S. <i>SGND</i>
<b>VR5</b>	1000V	1/10000	VR5 (1KΩ)	<i>VR1</i> V.S. <i>SGND</i>

The ES218 support the hazardous live voltage warning. When the voltage measured exceeds the 30V, the buzzer generates 2KHz beep and *ALARM* (pin38) drive high output (V+ level) periodically. It can remind the user to notice the hazardous voltage. The buzzer sound warning could be cancelled by *DISDGBP* (pin41).

#### 1.1.1. OL Selection

ES218 has a voltage OL selection feature archived by configuring the pin *CESEL* (pin40). In 1000V voltage mode, ES218 will show OL when the voltage is exceed the overflow level. If *CESEL* is connected to DGND, ES218 will have a 1010V overflow level in voltage mode. If *CESEL* connected to V-, the overflow level will be set to 610V in DCV and ACV mode. The configuration of *CESEL* is listed below.

**For ACV/DCV voltage modes:**

	<i>CESEL</i>		
	V-	DGND	Floating
<b>DCV</b>	<b>610V</b>	<b>1010V</b>	<b>1010V</b>
<b>ACV</b>	<b>610V</b>	<b>1010V</b>	<b>760V</b>



### 1.2. Current Measurement For Multi-meter

ES218 has 5 manual current measurement modes for multi-meter. The following table summarizes the full-scale range of each mode. When ES218 operates in the current measurement modes for multi-meter, it takes high input from pin *IVS* (pin100), low input from pin *SGND* and reference voltage from *VR* (pin10).

Mode	FC6	FC1~4	Full Scale	Input Terminal
<b>200.0uA<sup>2</sup></b>	0	0,0,0,1	20.00mV	<i>IVS</i> V.S. <i>SGND</i>
<b>2000uA</b>	1	0,0,0,1	200.0mV	<i>IVS</i> V.S. <i>SGND</i>
<b>20.00mA</b>	0	1,0,0,0	20.00mV	<i>IVS</i> V.S. <i>SGND</i>
<b>200.0mA</b>	1	1,0,0,0	200.0mV	<i>IVS</i> V.S. <i>SGND</i>
<b>20.00A<sup>1</sup></b>	1	0,0,0,0	200.0mV	<i>IVS</i> V.S. <i>SGND</i>

Note:

1. Connect *ASEL* (pin44) to V- will set maximum readings of input for 20.00A mode to 10.00A.
2. Pulled *S20uA* (pin71) to V- to change 200.0uA to 20.00uA display.

### 1.3. Current Measurement For Clamp-meter

ES218 supports 4 manual current measurement modes for Clamp meter application. The following table summarizes the Full-Scale range of each mode. It takes high input from *IVS* pin, low input from *SGND* and reference voltage from *VR*.

Mode	VST <sup>1</sup>	FC6	FC1~4	Full Scale	Input Terminal
<b>200.0A</b>	V-	0	0,0,0,1	20.00mV	<i>IVS</i> V.S. <i>SGND</i>
<b>2000A<sup>2</sup></b>		1	0,0,0,1	200.0mV	<i>IVS</i> V.S. <i>SGND</i>
<b>20.00A</b>		0	1,0,0,0	20.00mV	<i>IVS</i> V.S. <i>SGND</i>
<b>200.0A</b>		1	1,0,0,0	200.0mV	<i>IVS</i> V.S. <i>SGND</i>

Note:

1. Connect *VST* to V- will disable the “ $\mu_2$ ” / “m<sub>2</sub>” symbol on LCD panel.
2. Connect *ASEL* to V- will set maximum readings of input for 2000A modes to 1000A.





### 1.4. Resistance Measurement

A re-configurable divider provides a manual Full-Scale range in resistance measurement mode.

The following table summarizes the full-scale ranges and the reference resistors in each configuration.

Configuration	Full Scale Range	Relative Resistor	Equivalent value
OR1	200.0Ω	OR1	100Ω
OR2	2.000KΩ	VR5	1KΩ
OR3	20.00KΩ	VR4    VR1	10KΩ
OR4	200.0KΩ	VR3    VR1	100KΩ
OR5	2.000MΩ	VR2    VR1	1MΩ
OR6	20.00MΩ	VR1	10MΩ
OR7	200.0MΩ	VR1	100MΩ

### 1.5. Capacitance Measurement

The following table summarizes the eight ranges of capacitance measurement mode.

Configuration <sup>1</sup>	Full Scale Range	Relative Resistor	Measurement Period
C1 <sup>3</sup>	2.000nF	Ratio to C2	0.25 sec
C2 <sup>2</sup>	20.00nF	CAL	0.25 sec
C3	200.0nF	Ratio to C2	0.9 sec
C4	2.000uF	Ratio to C2	0.9 sec
C5	20.00uF	Internal matching	0.25 sec
C6	200.0uF	Internal matching	1.25 sec(max)
C7	2.000mF	Internal matching	2.5 sec(max)
C8	20.00mF	Internal matching	12.5 sec(max)

Note:

1. In order to obtain an accurate reading, a capacitor must be discharged before measurement begins. The chip has a built-in discharge mode to automatically discharge the capacitor. In discharge mode, the main-display shows **dIS.C**. Discharging through the chip is quite slow. We recommend users to discharge the capacitor with some other apparatus.
2. The C2 range is calibrated in calibration scheme.
3. The C1 range residual offset could be compensated by the small capacitors near to OVH pin.



### 1.6. Continuity Check

Continuity check shares the same configuration with 200.0Ω manual resistance measurement mode and has buzzer output to indicate continuity. The buzzer generates 2KHz beep and *ALARM* (pin 38) drive high output (V+ level) whenever the reading is less than 30Ω. The ES218 built in a high speed short detection circuit and the detection period could be less than 10ms.

### 1.7. Diode Measurement

Diode measurement mode shares the same configuration with 2.000V manual voltage measurement mode and has buzzer output to indicate continuity. The buzzer generates a 2KHz sound and *ALARM* (pin 38) drive high output (V+ level) whenever the reading is less than 30mV. The source output voltage is the same as V+ terminal. If the test circuit is open or the voltage drop between the two ports of the diode under test is larger than 2V or 2.8V (depends on *DIOV* pin level), the LCD panel will show “OL”.

	<i>DIOV</i>	
	DGND/Floating	V-
OL	2.000V	2.800V

### 1.8. Frequency Counter

The time base of the frequency counter is derived from an external crystal oscillator by

$$T_{\text{counter}} = \frac{2,000,000}{F_{\text{osc}}}$$

Where  $F_{\text{osc}}$  is the frequency of the crystal oscillator. Thus, the counter has a 1-second time base when a 4MHz oscillator is used. The frequency counter can select the proper range automatically or manually. Auto-range operation extends over six decades, from 200.0Hz to 20.00MHz. The following table summarizes the Full-Scale range of the frequency counter.

Range	Full Scale
FR1	200.0Hz
FR2	2.000KHz
FR3	20.00KHz
FR4	200.0KHz
FR5	2.000MHz
FR6	20.00MHz

\*If input frequency is less than 1.0Hz, ES218 will show **0.0Hz**



### 1.9. Electrical field detection mode (NCV)

ES218 supports a non-contact AC voltage measurement, which is called electric field measurement also. The ADC input is configured from *ADP* pin vs. *SGND*. When no or less electric field is detected, the LCD display shows “EF”. If the electric field is detected, the strength will be showed on the LCD display by “-“ not digits type. Level 1 (equivalent to 12.5% full scale of ADC) is “-“ and the level 4 (equivalent to 100% full scale of ADC) is “----“. Additional beeper (*BUZOUT* pin) and LED alarm (*ALARM* pin) will be output from ES218. The frequency of buzzer and LED alarm depends on the strength of electric field also. The Faster beeper means the stronger electric field (AC voltage) is sensed. The input voltage is taken from *ADP* pin(99) and the reference voltage is taken from *VR\_ADP* (pin11)

Mode	FC1~4	SLACDC / FC6	Full Scale	Input Terminal
EF	0,1,1,0	1,1	-	ADP V.S. SGND

EF test circuit

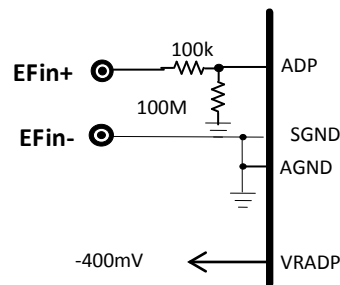





### 1.11. ADP

ES218 provides 4 manual range ADP measurement modes for user define. The *ADP* pin is auxiliary input terminal for ADC of ES218. The full scale for ADP mode is 200.0mV. If FC5=0, the minus sign will not be shown on LCD segment.

Mode	FC1~4	SLACDC / FC6	Full Scale	Input Terminal
ADP0	1,0,0,1	1,1	2000	ADP V.S. SGND
ADP1	0,0,1,1	1,1	200.0	ADP V.S. SGND
ADP2	0,0,1,0	1,1	20.00	ADP V.S. SGND
ADP3	0,1,0,1	1,1	2.000	ADP V.S. SGND

**Note:** If FC5 is set to V-, the minus sign will be disabled.

### 1.12. Auto Power Off (APO)

ES218 has a default auto power off function. If the meter is idle for more than the given idle time duration, the chip automatically turns the power off. The idle time to trigger the auto power off function is set to 30 minutes. When APO is occurred, the state of the meter is reserved. The APO symbol on the LCD panel indicates whether the auto power off is enabled or not. In some cases, user might want to disable Auto power off. There are two ways to disable this feature as following:

1. Power on the meter when any of the push functions, except for **HOLD**, is pressed down.

**Note:** Powering on the meter while pressing **HOLD** and lasts 2 seconds turns on all LCD segments until **HOLD** is pressed again.

### 1.13. Sleep

The meter enters sleep mode after auto power off. The *SLEEP* pin (pin43) asserts low (V-) in the sleep mode, and asserts high (V+, not 0V) after re-power on.

### 1.14. Re-Power On

After auto power-off, pushing any of the push function or changing the rotary mode can turn on the meter again. If the meter is re-powered on by changing the rotary mode, the saved state is cleared. If the meter is re-powered on by push functions, the chip restores the saved state and enters **HOLD** mode. The LCD displays the saved value.



### 1.15. Hazardous Voltage Indication

The ES218 could provide the AC/DC hazardous voltage indication for voltage/resistor/ diode modes. Of course, the indication could support LCD symbol /LED /Buzzer driving simultaneously. Especially ES218 could detect the AC voltage in DCV mode and detects the DC voltage in ACV mode. It means if not proper AC or DC voltage signal exists on the DUT when DCV or ACV measurement mode is set, the HV indication will be still active.

#### HV indication criterion

Function / Range	DC voltage (typ.)	AC voltage (typ.)
AC mV	> $\pm 3V$	OL
AC 4V	> $\pm 20V$	OL
AC 40V – 1000V	> $\pm 100V$	> 30Vrms
DC mV	OL	> 3Vrms (40-1kHz)
DC 4V	OL	> 20Vrms (40-1kHz)
DC 40V-1000V	> $\pm 30V$	> 90Vrms (40-1kHz)
Freq. mode	> $\pm 40V$	> 30Vrms (40-1kHz)
Res/Diode modes	> $\pm 10V$	> 10Vrms (40-1kHz)

**Note: If AC+DC signal is applied, the voltage criterion will be changed.**

### 1.16. Low Battery Voltage Detection



ES218 provides a voltage detection input (pin 89: *LBAT9*) for non-3V battery application. When *LBAT9* is less than *VRH* terminal voltage, the LCD segment of low battery will appear. For 3V battery application, pull *LBAT9* to *DGND* directly and the same detection will be made when *V-* is less than 2.3V. When the Low battery status lasts for 10 seconds, the LCD segment of low battery will be blinking. When the symbol is blinking for 20 seconds, the operation of meter will be inhibited and LCD panel will show “Lo.bt”. In this case, it is suggested to replace a new battery immediately. After “Lo.bt” appears and lasts for 60 seconds, ES218 will enter to auto power off mode.

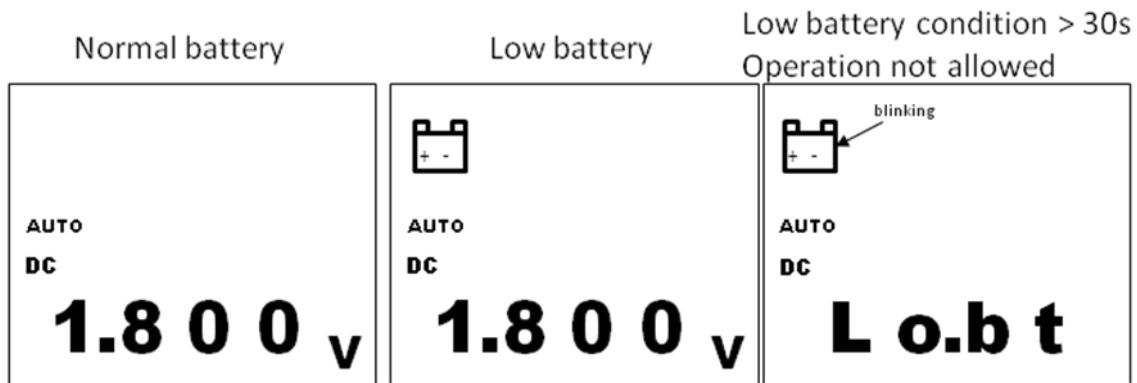

Low battery test (9V)

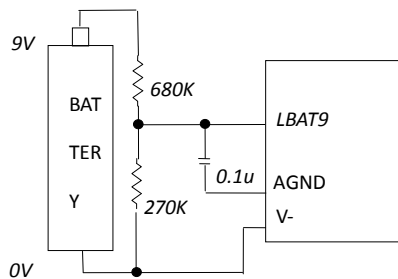

## 2.Measurement Mode Switching



Measurement mode depends on the logic level of *SLACDC*, *FC1*, *FC2*, *FC3*, *FC4*, *FC5*, *FC6* and **KEY** selection. When *FC5/FC6* are high (kept floating), the measurement mode list is shown below:

<i>SLACDC</i>	<i>FC1</i>	<i>FC2</i>	<i>FC3</i>	<i>FC4</i>	Mode	<b>KEY</b> selection
0	1	0	1	1	DC 200.0V	DCV ↔ ACV
0	1	1	0	1	DC 20.00V	DCV ↔ ACV
0	1	1	1	1	DC 200.0mV	DCmV ↔ ACmV
0	1	1	1	0	DC 2.000V	DCV ↔ ACV
0	0	0	0	0	DC 20.00A <sup>2</sup>	DCA ↔ ACA
0	1	1	0	0	20.00 MΩ	----
0	1	0	0	0	DC 200.0mA <sup>23</sup>	DCmA ↔ ACmA
0	1	0	1	0	2.000 MΩ	----
0	1	0	0	1	200.0 kΩ	----
0	0	0	1	1	200.0 Ω	----
0	0	0	0	1	DC 2000 uA <sup>23</sup>	DCuA ↔ ACuA
0	0	1	1	1	DC 1000V	DCV ↔ ACV
0	0	0	1	0	Frequency mode (AUTO)	----
0	0	1	1	0	2.000 kΩ	----
0	0	1	0	0	1350 °C	°C ↔ °F
0	0	1	0	1	20.00 kΩ	----
1	1	0	1	1	AC 200.0V	ACV ↔ DCV
1	1	1	0	1	AC 20.00V	ACV ↔ DCV
1	1	1	1	1	AC 200.0mV	ACmV ↔ DCmV
1	1	1	1	0	AC 2.000V	ACV ↔ DCV
1	0	0	0	0	AC 20.00A <sup>2</sup>	ACA ↔ DCA
1	1	1	0	0	Continuity mode	----
1	1	0	0	0	AC 200.0mA <sup>23</sup>	ACmA ↔ DCmA
1	1	0	1	0	Diode mode	----
1	1	0	0	1	ADP0 (±2000) <sup>1</sup>	----
1	0	0	1	1	ADP1 (±200.0) <sup>1</sup>	----
1	0	0	0	1	AC 2000uA <sup>23</sup>	ACuA ↔ DCuA
1	0	1	1	1	AC 1000V	ACV ↔ DCV
1	0	0	1	0	ADP2 (±20.00) <sup>1</sup>	----
1	0	1	1	0	EF mode	----
1	0	1	0	0	2462 °F	°F ↔ °C
1	0	1	0	1	ADP3 (±2.000) <sup>1</sup>	----

Note:

1. When *FC5* is high, the ADP0, ADP1, ADP2 and ADP3 modes can display minus sign.
2. These modes could be designed for multimeter current modes, please refer to section 1.2.
3. These modes could be designed for clampmeter current modes, please refer to section 1.3.

### Measurement Mode Switching (Continued)





Measurement mode depends on the logic level of *SLACDC*, *FC1*, *FC2*, *FC3*, *FC4*, *FC5* and **KEY** selection. When *FC5* is low (pulled to V-), the KEY function is disabled in most modes. The measurement mode list is shown below: (Note: *FC6* is high)

<i>SLACDC</i>	<i>FC1</i>	<i>FC2</i>	<i>FC3</i>	<i>FC4</i>	Mode	KEY selection & Remarks
0	1	0	1	1	DC 200.0V	----
0	1	1	0	1	DC 20.00V	----
0	1	1	1	1	DC 200.0mV	----
0	1	1	1	0	DC 2.000V	----
0	0	0	0	0	DC 20.00A <sup>2</sup>	----
0	1	1	0	0	20.00 MΩ	----
0	1	0	0	0	DC 200.0mA <sup>23</sup>	----
0	1	0	1	0	2.000 MΩ	----
0	1	0	0	1	200.0 kΩ	----
0	0	0	1	1	200.0 Ω	----
0	0	0	0	1	DC 2000 uA <sup>23</sup>	----
0	0	1	1	1	DC 1000V	----
0	0	0	1	0	Frequency mode (AUTO)	----
0	0	1	1	0	2.000 kΩ	----
0	0	1	0	0	1350 °C	----
0	0	1	0	1	20.00 kΩ	----
1	1	0	1	1	AC 200.0V	----
1	1	1	0	1	AC 20.00V	----
1	1	1	1	1	AC 200.0mV	----
1	1	1	1	0	AC 2.000V	----
1	0	0	0	0	AC 20.00A <sup>2</sup>	----
1	1	1	0	0	Continuity mode	----
1	1	0	0	0	AC 200.0mA <sup>23</sup>	----
1	1	0	1	0	Diode mode	----
1	1	0	0	1	ADP0 (2000) <sup>1</sup>	----
1	0	0	1	1	ADP1 (200.0) <sup>1</sup>	----
1	0	0	0	1	AC 2000uA <sup>23</sup>	----
1	0	1	1	1	AC 1000V	----
1	0	0	1	0	ADP2 (20.00) <sup>1</sup>	----
1	0	1	1	0	EF mode	----
1	0	1	0	0	2462 °F	----
1	0	1	0	1	ADP3 (2.000) <sup>1</sup>	----

Note:

1. When *FC5* is low, the ADP0, ADP1, ADP2 and ADP3 modes can't display minus sign.
2. These modes could be designed for multi-meter current modes, please refer to section 1.2.
3. These modes could be designed for clamp-meter current modes, please refer to section 1.3.

### Measurement Mode Switching (Continued)



Measurement mode depends on the logic level of *SLACDC*, *FC1*, *FC2*, *FC3*, *FC4*, *FC5* and **KEY** selection. When *FC6* is low (pulled to V-), the capacitance measurement and extra current measurement mode lists are shown below:

<i>SLACDC</i>	<i>FC1</i>	<i>FC2</i>	<i>FC3</i>	<i>FC4</i>	<i>FC5</i>	Mode	<b>KEY</b> selection & Remaks
0	0	0	1	1	X	2.000 nF	----
0	0	1	1	0	X	20.00 nF	----
0	0	1	0	1	X	200.0 nF	----
0	1	0	0	1	X	2.000 uF	----
0	1	0	1	0	X	20.00 uF	----
0	1	1	0	0	X	200.0 uF	----
0	0	1	0	0	X	2.000 mF	----
0	0	0	1	0	X	20.00 mF	----
0	1	1	1	1	X	Cap (AUTO)	----
0	1	1	1	0	X	200.0 MΩ	----
0	1	0	0	0	1	DC 20.00 mA <sup>12</sup>	DCmA ↔ ACmA
0	0	0	0	1	1	DC 200.0 uA <sup>12</sup>	DCuA ↔ ACuA
1	1	0	0	0	1	AC 20.00 mA <sup>12</sup>	ACmA ↔ DCmA
1	0	0	0	1	1	AC 200.0 uA <sup>12</sup>	ACuA ↔ DCuA
0	1	0	0	0	0	DC 20.00 mA <sup>12</sup>	----
0	0	0	0	1	0	DC 200.0 uA <sup>12</sup>	----
1	1	0	0	0	0	AC 20.00 mA <sup>12</sup>	----
1	0	0	0	1	0	AC 200.0 uA <sup>12</sup>	----

Note:

1. These modes could be designed for multi-meter current modes, please refer to section 1.2.
2. These modes could be designed for clamp-meter current modes, please refer to section 1.3.

\



### 3. Push Function

All the enabled push functions will be reset when the measurement mode is changed when *FC1-FC5* modes are changed. The following table lists the available function versus every measurement mode.

	MMX	KEY	HOLD/BKLIT*
Voltage mode	O	O	O
mV mode	O	O	O
Current Mode for Multimeter	O	O	O
Current Mode for Clampmeter	O	O	O
Resistance	O	X	O
Continuity	O	X	O
Diode mode	O	X	O
Frequency	X	X	O
Capacitance	O	X	O
Temperature	O	O	O
EF Mode	X	X	O
ADP mode	O	X	O

Note:

Push **HOLD** key and last for 2 seconds will active the back light output driver (BKOUT).

#### 3.1. HOLD and BKOUT output Feature



HOLD mode makes the meter stop updating the LCD panel. This mode can be nested in most of the special modes. Enabling HOLD function in automatic mode makes the meter switch to manual mode, but the range remains the same. ES218 provides a backlight output feature. To activate backlight output feature, press down the **HOLD** key and last for 2 seconds. The meter will enable output from BKOUT.

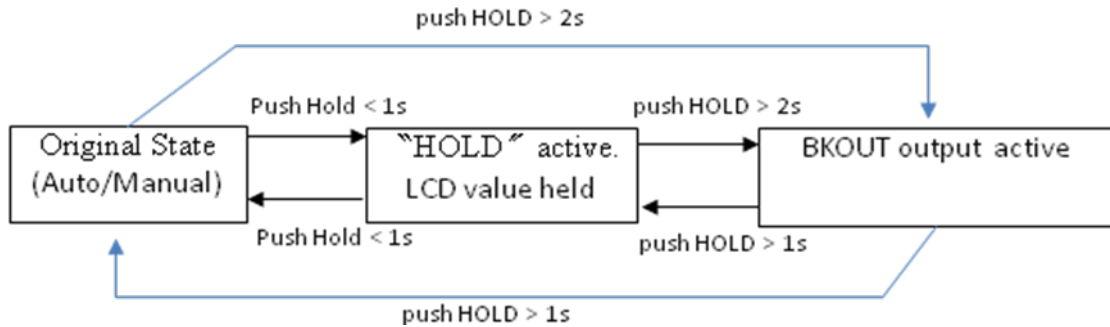

### 3.2. KEY

See Section “Measurement Mode Switching” for the function of this pin.

### 3.3. Max/Min + HOLD

The meter displays the maximum or minimum value of the input in Max/Min mode. When **MMX** key is pressed for the first time, the meter displays the maximum value. The meter displays the minimum value, when it is pressed again. When **MMX** key is pressed for the third time, the meter displays current value. The meter returns to normal operation if **MMX** is pressed and held for longer than one second. Pressing **HOLD** in Max/Min mode makes the meter stop updating the maximum or the minimum value.

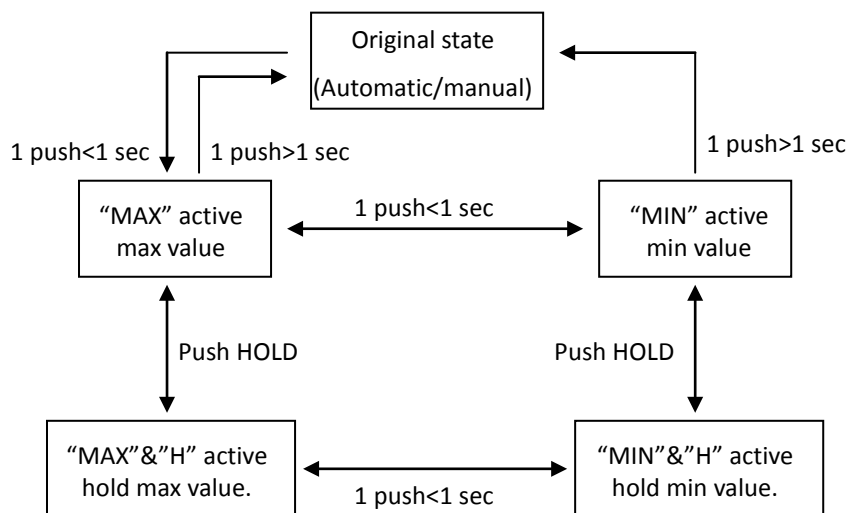

## 4. Miscellaneous



The conditions, which the meter turns on the buzzer, include:

- (1) Changing measurement mode generates one beep.
- (2) Pressing any of the push functions generates one beep, if the function is valid.
- (3) Power on and re-power on generate one beep.
- (4) Input overflow in voltage and current mode generates one beep every 0.3 seconds (or 3.33 beeps per second.)
- (5) Hazard voltage indication is active generates one beep per second and could be disabled by *DISDGBP* pin.
- (6) Continuity(diode) check generates a continuous 2KHz beep whenever the measurement is less than  $30\Omega(30mV)$
- (7) Auto power off generates a 2KHz beep which lasts for 1.5 seconds.

The following figures show the output waveform from the BUZOUT pin.

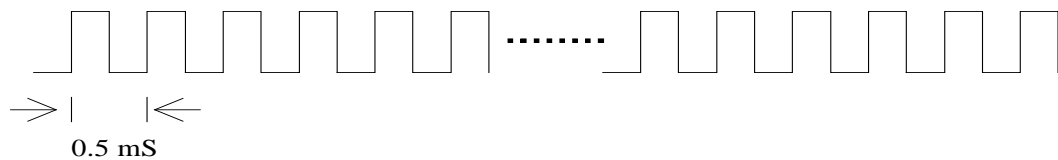

(a) Continuous 2KHz beep

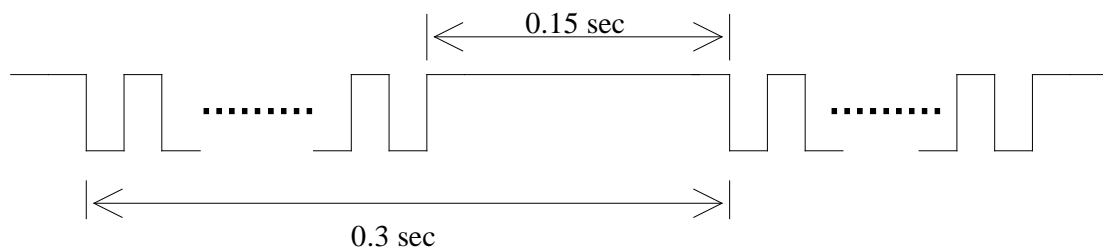

(b) 3.33 beep/sec

#### 4.1. LCD Panel



	S01	S02	S03	S04	S05	S06	S07	S08	S09
BP1		AUTO		4B	3A	3B	2A	2B	1A
BP2	APO	AC	4A	4G	3F	3G	2F	2G	1F
BP3	DANGE	MINUS	4F	4C	3E	3C	2E	2C	1E
BP4	LBAT	DC	4E	4D	DP3	3D	DP2	2D	DP1

	S10	S11	S12	S13	S14	S15
BP1	1B	BUZZER	HOLD	$\mu 2$	M	n
BP2	1G	DIODE	MAX	m2	K	$\mu 1$
BP3	1C	$^{\circ}\text{C}$	MIN	V	$\Omega$	m1
BP4	1D	$^{\circ}\text{F}$	ADP	A	Hz	F

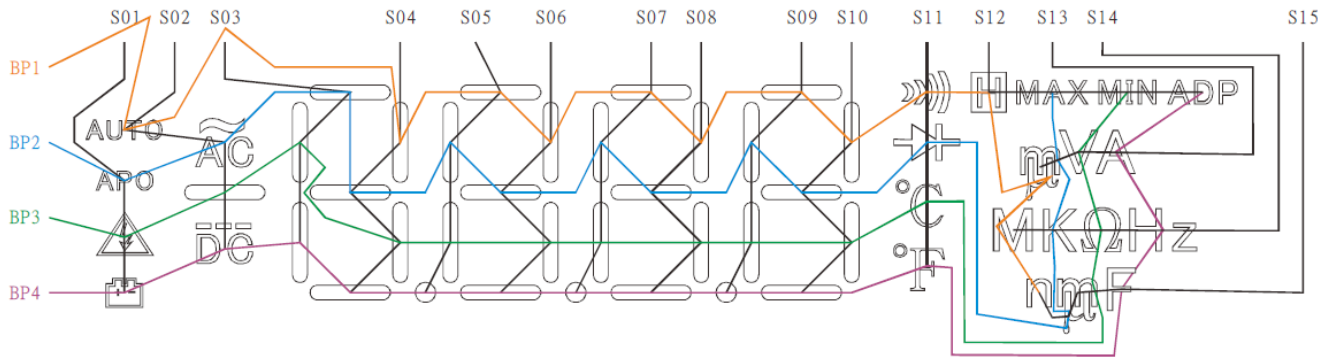

### LCD Backplane Waveform

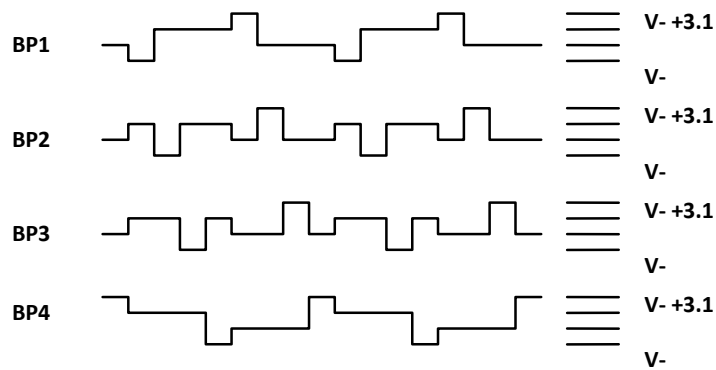

### 4.2. LCD Display On Condition



LCD Annunciator	Condition
V	In voltage measurement mode, and diode measurement mode.
A	In current measurement mode.
$\Omega$	In resistance measurement mode, and continuity mode.
F	In capacitance measurement mode.
m <sub>1</sub>	In capacitor measurement mode and the full scale range is in the order of mF.
$\mu_1$	In capacitor measurement mode and the full scale range is in the order of $\mu$ F.
n	In capacitor measurement mode and the full scale range is in the order of nF.
	In continuity check mode.
	In diode mode.
Hz	In frequency mode.
ADP	When ADP0-3 mode is active.
DC	In DC voltage or DC current mode.
AC	In AC voltage or AC current mode.
AUTO	When automatic full scale range selection is enabled. (Hz or Cap Auto mode)
HOLD	When HOLD function is enabled.
MAX	When MAX function is enabled.
MIN	When MIN function is enabled.
m <sub>2</sub>	In voltage or current measurement mode and the full scale range is in the order of $10^{-3}$ .
$\mu_2$	In current measurement mode and the full scale range is in the order of $\mu$ A.
M	In resistance measurement mode and the full scale range is in the order of M $\Omega$ .
K	In resistance measurement mode and the full scale range is in the order of K $\Omega$ .
$^{\circ}$ C	In temperature measurement mode and when the unit is $^{\circ}$ C .
$^{\circ}$ F	In temperature measurement mode and when the unit is $^{\circ}$ F .
(HV)	When the reading is exceeding default hazardous live voltage or OL in DCV or ACV, or not proper voltage applied on Res/Cap/Diode/Hz modes, the HV warning symbol will be displayed.
APO	When auto power off function is enabled.
LBAT	When battery voltage is too low



### 4.3 Operating Timing

ES218 incorporates a dual slope ADC with four phases: ZI, AZ, INT and DINT. The timing of each phase is listed below.

- (1) Voltage / Diode /ADP

Phase	High resolution
ZI	20ms
AZ	20ms
INT	100ms
DINT	110ms

- (2) Current mode for multimeter/Auto Current mode for clampmeter:

Phase	DC / AC	DC Lower Range	DC/AC 999.9A
ZI	50ms	20ms	20ms
AZ	25ms	20ms	20ms
INT	100ms	1000ms	100ms
DINT	110ms	110ms	260ms

- (3) Continuity / Ohm measurement:

Phase	Time	Time (200M)
ZI	20ms	20ms
AZ	20ms	20ms
INT	25ms	25ms
DINT	185ms	585ms

- (4) Frequency : Every conversion takes 1.05 second.

- (5) Temperature measurement:

Phase	Time
ZI	20ms
AZ	20ms
INT	500ms
DINT	210ms

Note:

1. In the frequency measurement with auto mode, if the range is changed, the internal clock rate will increase ten times and the new measurement cycle becomes 1/10 times of the original cycle until the range is stable.





Application Circuit

1. AVG Circuit

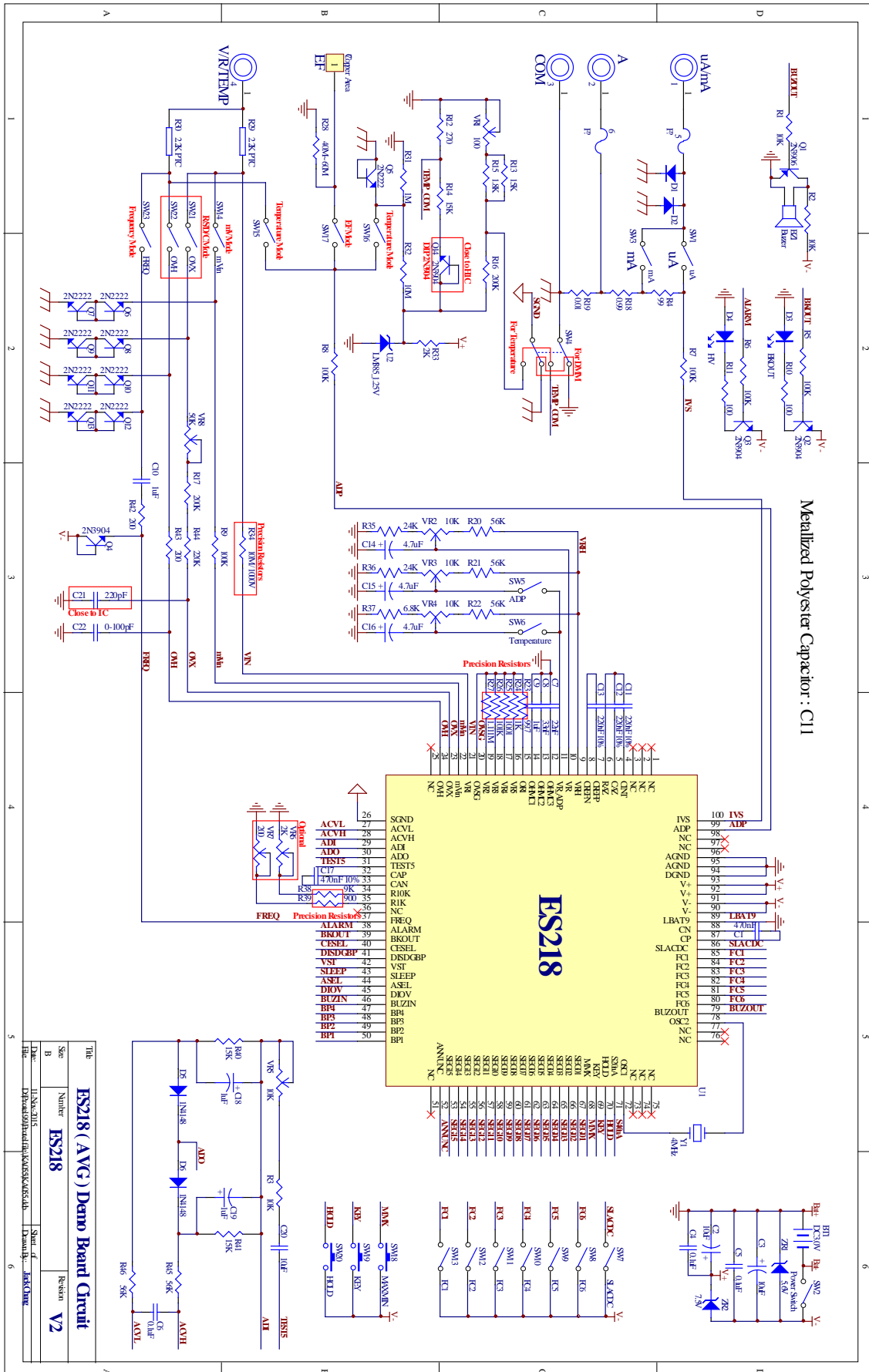



■ Package Information

■ 100L LQFP Outline drawing

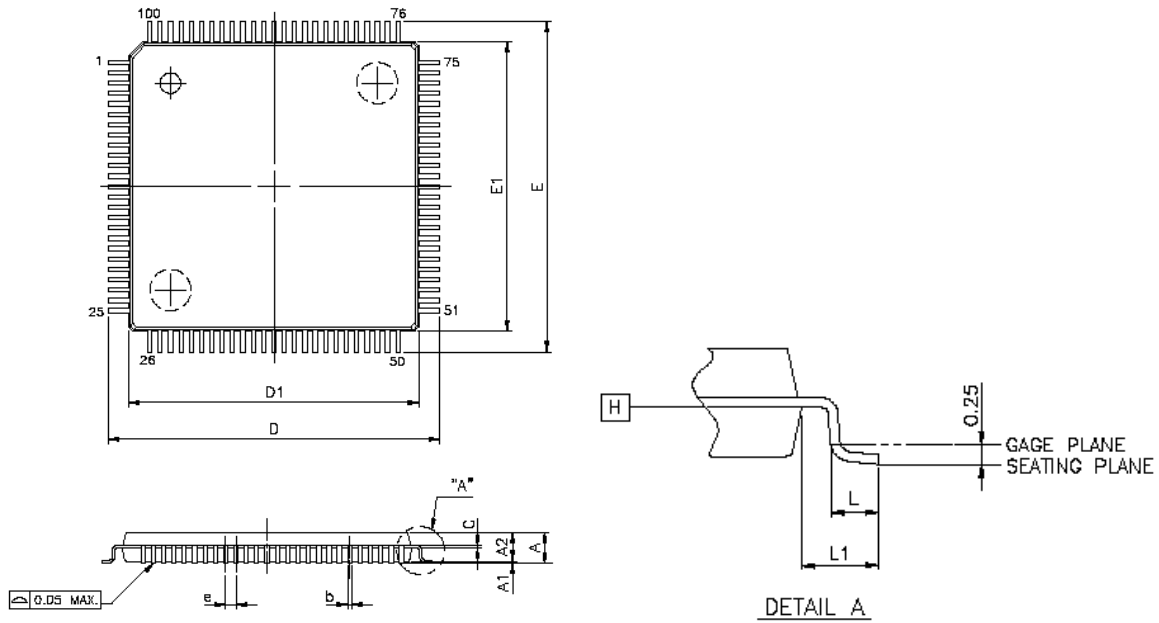

Dimension parameters

VARIATIONS (ALL DIMENSIONS SHOWN IN MM)

SYMBOLS	MIN.	NOM.	MAX.
A	--	--	1.60
A1	0.05	--	0.15
A2	1.35	1.40	1.45
b	0.17	0.20	0.27
c	0.09	0.127	0.20
D	16.00 BSC		
D1	14.00 BSC		
E	16.00 BSC		
E1	14.00 BSC		
e	0.50 BSC		
L	0.45	0.60	0.75
L1	1.00 REF		