



## Features

- 6,600 counts dual LCD display
- 128L QFP package
- 3.3V DC power supply
- Slow ADC Conversion rate : 2.8 times/s
- Bar-graph ADC conversion rate: 28 times/s
- Full automatic measurement
  - \*Voltage measurement: 660.0mV – 1000V
  - \*Current measurement:  $\mu$ A/mA/A
  - \*Frequency sub-display with Voltage or Current mode (VAHz): 66.00Hz ~ 66.00kHz
  - \*Resistance measurement: 660.0 $\Omega$  – 66.00M $\Omega$
  - \*Resistance measurement for Clampmeter mode: 660.0 $\Omega$  – 66.00K $\Omega$
  - \*Capacitance measurement: 6.600nF – 66.00mF
- (Taiwan patent no.: 323347, 453443)  
(China patent no.: 748600)
- \*Frequency counter with duty cycle display: 66.00Hz – 66.00MHz , 1% – 99% (<10kHz)
- Current modes for clamp meter with ZERO function
- AC modes with frequency dual display
- Diode measurement & continuity check
- 4 ADP modes with external reference voltage and independent “ADP” segment on LCD panel
- Temperature mode with internal scale translation circuit from  $^{\circ}$ C to  $^{\circ}$ F
- Push functions:
  - \*KEY function
  - \*PEAK function (Taiwan patent no.: 476418)
  - \*Range change function
  - \*Relative function
  - \*Zero function: DCA clampmeter only
  - \*Data hold function with data record feature
  - \*MAX/MIN function
  - \*Back light function

- Low pass filter auto switching mode for ACA/ACV measurement  
(Taiwan patent no.: 361281)  
(China patent no.: 876287)
- Band-gap reference voltage output
- CE selection (DC/AC 1010V, DC/AC 610V)
- Serial data output (RS232 format)
- LCD segment check when power on
- Auto power off (30min/15min)
- Sleep state indicative signal output
- Re-power on
- On-chip buzzer driver
- Low battery detection

## Description

ES51965 is an integrated analog-to-digital converter (ADC) with dual 6,600-count LCD display (4-digit main-display and 4-digit sub-display), automatic range selection, and 3.3V DC power supply. Automatic range selection is provided for voltage (AC/DC) measurement, resistance measurement, current measurement, capacitance measurement, and frequency counter. Expensive and bulky mechanical range switches are not required. Other features include peak-hold, relative value display, offset removing feature for DCA clampmeter, data holding, maximum and minimum value holding, duty cycle measurement, diode measurement, temperature measurement, continuity checking, low battery detection, auto power off, re-power on, backlight driver, buzzer driver and RS232 data output.



**Application**

Digital multimeter

Clamp meter

**Pin Assignment**

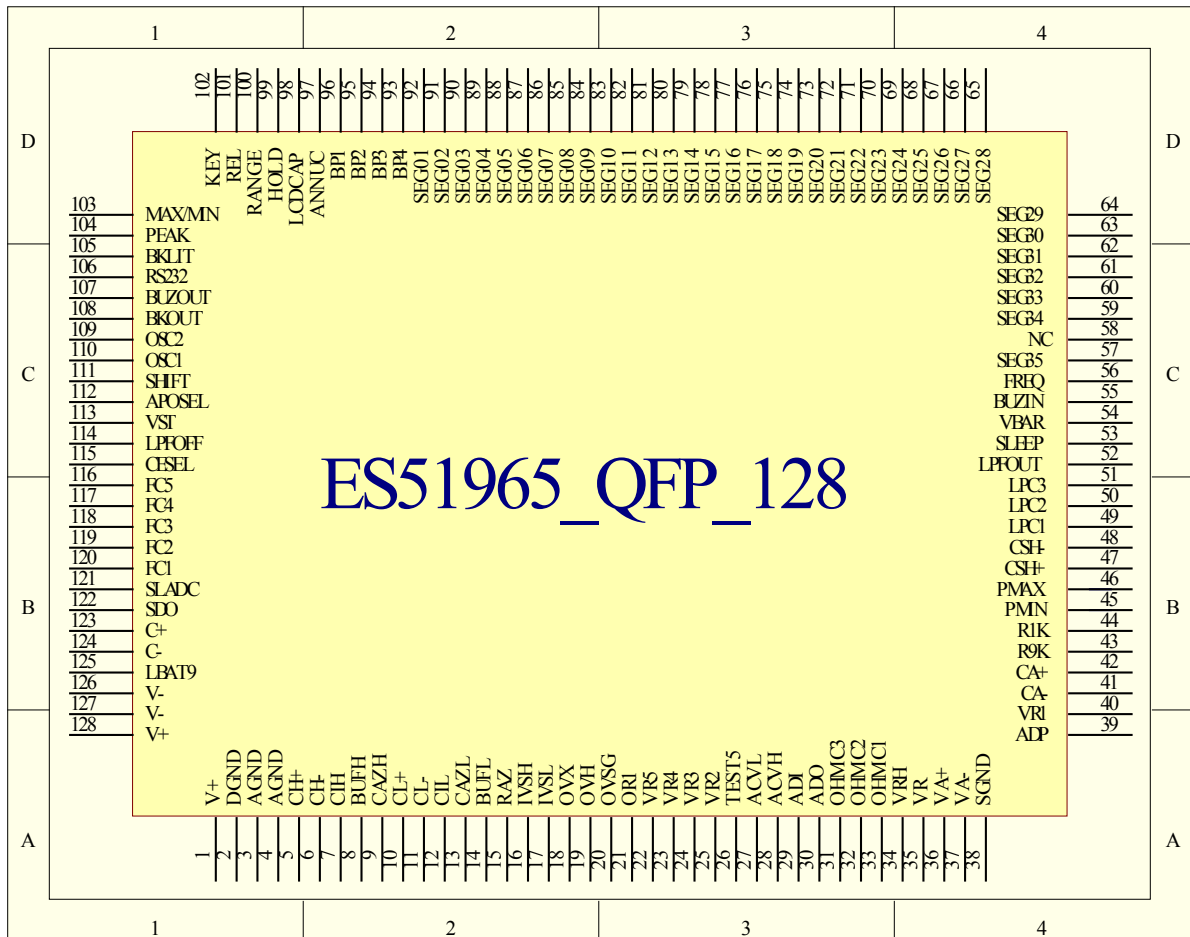

**Pin Description**

Pin No	Symbol	Type	Description
1	V+	O	Output of on-chip DC-DC converter.
2	DGND	P/G	Digital ground.
3	AGND	P/G	Analog ground.
4	AGND	P/G	Analog ground.
5	CH+	IO	Positive connection for reference capacitor of high-speed A/D.
6	CH-	IO	Negative connection for reference capacitor of high-speed A/D.
7	CIH	O	High-speed integrator output. Connect to integral capacitor.
8	BUFFH	O	High-speed buffer output pin. Connect to integral resistor.
9	CAZH	O	High-speed auto-zero capacitor connection.
10	CL+	IO	Positive connection for reference capacitor of high-resolution A/D.
11	CL-	IO	Negative connection for reference capacitor of high-resolution A/D.
12	CIL	O	High-resolution integrator output. Connect to integral capacitor.
13	CAZL	O	High-resolution auto-zero capacitor connection.
14	BUFFL	O	High-resolution Buffer output pin. Connect to integral resistor
15	RAZ	O	Buffer output pin in AZ and ZI phase.
16	IVSH	I	Current measurement input for 6600 $\mu$ A, 660mA and 66A modes.
17	IVSL	I	Current measurement input for 660 $\mu$ A, 66mA.
18	OVX	I	Sense input for resistance/capacitance measurement
19	OVH	O	Output connection for resistance measurement
20	OVSG	O	Sense low voltage for resistance/voltage measurement
21	OR1	O	Reference resistor connection for 660.00 $\Omega$ range
22	VR5	O	Voltage measurement $\div$ 10000 attenuator(1000V)
23	VR4	O	Voltage measurement $\div$ 1000 attenuator(660.0V)
24	VR3	O	Voltage measurement $\div$ 100 attenuator(66.00V)
25	VR2	O	Voltage measurement $\div$ 10 attenuator(6.600V)
26	TEST5	O	Buffer output of OVSG
27	ACVL	O	DC signal low input in ACV/ACA mode. Connect to negative output of external AC to DC converter.
28	ACVH	O	DC signal high input in ACV/ACA mode. Connect to positive output of external AC to DC converter.
29	ADI	I	Negative input of internal AC to DC OP Amp.
30	ADO	O	Output of internal AC to DC OP Amp.
31	OHMC3	O	Filter capacitor connection for resistance mode.
32	OHMC2	O	Filter capacitor connection for resistance mode.
33	OHMC1	O	Filter capacitor connection for resistance mode.
34	VRH	O	Output of band-gap voltage reference. Typically $-1.23$ V
35	VR	I	Reference input voltage connection. Typically $-400$ mV
36	VA+	I	For ADP mode. De-integrating voltage positive input. The input should be higher than VA-.
37	VA-	I	For ADP mode. De-integrating voltage negative input. The input should be lower than VA+.
38	SGND	G	Signal Ground.
39	ADP	I	Measurement input in ADP mode.
40	VR1	I	Measurement Input. Connect to a precise 10M $\Omega$ resistor.
41	CA-	IO	Negative auto-zero capacitor connection for capacitor measurement
42	CA+	IO	Positive auto-zero capacitor connection for capacitor measurement
43	R9K	O	Connect to a precise 9K $\Omega$ resistor for capacitor measurement.
44	R1K	O	Connect to a precise 1K $\Omega$ resistor for capacitor measurement.
45	PMIN	O	Minimum peak hold output
46	PMAX	O	Maximum peak hold output.
47	CSH+	IO	Cap for duty-cycle mode
48	CSH-	IO	Cap for duty-cycle mode
49	LPFC1	O	Capacitor C1 connection for internal low-pass filter



50	LPFC2	O	Capacitor C2 connection for internal low-pass filter
51	LPFC3	O	Capacitor C3 connection for internal low-pass filter
52	LPFOUT	O	Capacitor C1 connection for internal low-pass filter
53	SLEEP	O	Sleep mode indicator, asserts low in SLEEP mode.
54	VBAR	I	In temperature mode, it is used to control decimal point. In $\mu$ A or mA modes, it is used to control the ' $\mu$ ' or 'm' sign.
55	BUZIN	I	Pull to V- to enable the BUZOUT.
56	FREQ	I	Frequency counter input, offset V-/2 internally by the chip.
57,59-92	SEG35 – SEG01	O	LCD segment line 01 – 35
93	BP4	O	LCD backplane 4
94	BP3	O	LCD backplane 3
95	BP2	O	LCD backplane 2
96	BP1	O	LCD backplane 1
97	ANNUNC	O	Square wave output at the backplane frequency, synchronized to BP1. ANNUNC can be used to control display annunciator. Connect a LCD segment to ANNUNC to turn it on; connect an LCD segment to its backplane to turn it off.
98	LDCAP	I	LCD bias voltage bypass capacitor
99	HOLD	I	Pulse to V- to enable HOLD function.
100	RANGE	I	Pulse to V- to enable manual mode and manual range selection.
101	REL_ZERO	I	Pulse to V- to enable Relative function or Zero function.
102	KEY	I	Pulse to V- to change mode. In ADP mode, if this pin is connected to V-, the buzzer output will be off when the ADP input overflows.
103	MAX/MIN	I	Pulse to V- to enable MAX/MIN function.
104	PEAK	I	Pulse to V- to enable Peak MAX/Peak MIN hold function
105	BKLIT	I	Back light function. Pulse low to set BKOUT pin output.
106	RS232	I	Assert low to enable serial data output.
107	BUZOUT	O	Outputs a 2KHz audio frequency signal for driving piezoelectric buzzer when BUZIN is low.
108	BKOUT	O	If BKLIT function is enabled, this pin will change from V- to V+ For 60 sec, once press BKLIT pin again within 60 sec, this pin will Change back to V-.
109	OSC2	O	Crystal oscillator output connection
110	OSC1	I	Crystal oscillator input connection
111	SHIFT	I	Pull to V- to enable display-shift feature on duty cycle mode
112	APOSEL	I	Idle time selection for auto power off feature.
113	VST	I	Pull to V- to enable the auto range voltage mode to start from 660.0V
114	LPFOFF	I	Pull to V- to disable the internal Low pass filter in measurement
115	CESEL	I	CE selection feature control pin.
116	FC5	I	Switch 5 for function selection.
117	FC4	I	Switch 4 for function selection.
118	FC3	I	Switch 3 for function selection.
119	FC2	I	Switch 2 for function selection.
120	FC1	I	Switch 1 for function selection.
121	SLACDC	I	Select initial state.
122	SDO	O	Serial data output
123	C+	O	Positive capacitor connection for on-chip DC-DC converter.
124	C-	O	Negative capacitor connection for on-chip DC-DC converter.
125	LBAT9	I	Low battery configuration input. If battery is used, the low battery segment is displayed when the voltage of this pin is less than VRH (-1.23V)
126	V-	P	Negative supply voltage.
127	V-	P	Negative supply voltage.
128	V+	O	Output of on-chip DC-DC converter.

### Absolute Maximum Ratings

Characteristic	Rating
Supply Voltage (V- to AGND)	-4V
Analog Input Voltage	V- -0.6 to V+ +0.6
V+	V+ $\geq$ (AGND/DGND+0.5V)
AGND/DGND	AGND/DGND $\geq$ (V- -0.5V)
Digital Input	V- -0.6 to DGND +0.6
Power Dissipation. Flat Package	500mW
Operating Temperature	0°C to 70°C
Storage Temperature	-25°C to 125°C

### Electrical Characteristics

TA=25°C, V- = -3.3V

Parameter	Symbol	Test Condition	Min.	Typ.	Max	Units
Power supply	V-		—	-3.3	—	V
Operating supply current In DCV mode	I <sub>DD</sub>	Normal operation	—	1.8	2.5	mA
	I <sub>SS</sub>	In sleep mode	—	5	10	μA
Voltage roll-over error	REV	10MΩ input resistor	—	—	±0.1	%F.S <sup>1</sup>
Voltage nonlinearity	NLV	Best case straight line	—	—	±0.1	%F.S <sup>1</sup>
Input Leakage			-10	1	10	PA
Zero input reading		10MΩ input resistor	-000	000	+000	counts
Band-gap reference voltage	V <sub>REF</sub>	100KΩ resistor between VRH and AGND	-1.3	-1.2	-1.1	V
Open circuit voltage for 660Ω measurement			—	-3.3	—	V
Open circuit voltage for other Ω measurement			-1.19	-1.08	-0.97	V
Peak to peak backplane drive voltage		-3.5V ≤ V ≤ -2.2V	3.0	3.1	3.2	V
Internal pull-high to 0V current		Between V- pin and HOLD, RANGE, KEY, FC1-FC5 BKLIT,MAXMIN	—	1.2	—	μA
		Between V- pin and RS232	—	11	—	
AC frequency response at 6.600V range		±1%	—	40-400	—	HZ
		±5%	—	400-2000	—	
3dB frequency for LPF mode		LPF auto ON when Hz < 500Hz(±3%)		7.5		kHz
Reference voltage temperature coefficient	TC <sub>RF</sub>	100KΩ resistor Between VRH 0°C < TA < 70°C	—	100	—	ppm/°C
Capacitance measurement Accuracy <sup>2</sup>		6.6nF – 66mF	-2.0 <sup>2</sup>	—	2.0 <sup>2</sup>	%F.S
			-3	—	3	counts

Note:

1. Full Scale
2. When capacitance measurement (Clamp mode) is selected, the additional error +1% should be increased.



## Function Description

### 1. Dual Display

#### 1.1 Introduction

ES51965 configures a dual display LCD driver for multi-meter applications. The dual display includes main-display and sub-display. Each display has 4 digits to show up to 6600 counts. The simplified representation of dual display is shown below. Main-display always shows current measurement value, however sub-display usually shows sub-measurement mode or some special reading, for example, maximum reading, minimum reading, and reference value of relative mode. By the dual display feature, ES51965 can also shows two different measurement mode at the same time, for example, AC voltage with frequency, frequency mode with duty cycle. It's very convenient for user to observe the ac voltage and frequency at the same time without changing the rotary switch or pushing any function button. Other features achieved by dual display will be introduced in later sections. The full LCD configuration is shown at [section 6.1 of page 27](#).

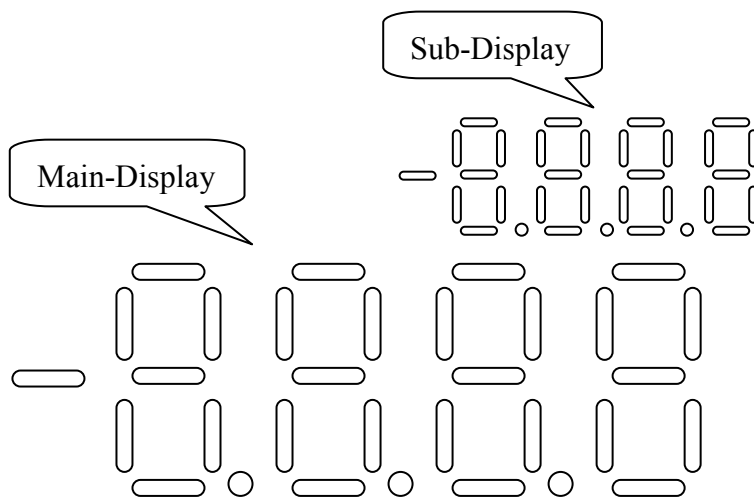

### 1.2 Dual display V.S. measurement mode

The main-display always shows reading in main measurement mode, and sub-display shows reading in sub-measurement mode or special function. The configuration is shown at the table below.

<b>Main measurement mode</b>	<b>Main-display</b>	<b>Sub-display default</b>
DC voltage	DC voltage	N/A
AC voltage	AC voltage	frequency
DC current	DC current	N/A
AC current for multimeter	AC current	frequency
AC current for clampmeter	AC current	frequency
Resistance mode	Resistance	N/A
Capacitance mode	Capacitance	N/A
Frequency mode	Frequency	Duty cycle
Continuity Check	Resistance	N/A
Diode mode	Voltage	N/A
Temperature mode	Temperature	N/A
ADP mode	A/D result	N/A

Note: N/A means that sub-display shows nothing if no push function is enabled.

### 1.3 Dual display V.S. push function

With dual display, user can observe current measurement result and special function at the same time. In other single-display DMM, it can not show the current value when some special function, for example, Peak-hold, Relative, Max/Min, is enabled. In order to see the current measurement value, the enabled function must be canceled.

<b><i>Push function</i></b>	<b><i>Main-display</i></b>	<b><i>Sub-display</i></b>
Enable Hold	Stop updating	Stop updating
PEAK HOLD	Current value	Max. Peak or Min Peak
Max/Min	Current value	Max. or Min. of current value
Relative	Relative value <sup>1</sup>	Reference Value
Zero	Modified value <sup>2</sup>	N/A

<sup>1</sup>Relative value = Current A/D result – Reference value

<sup>2</sup>Modified value = Current A/D result – zero offset value.

## 2. Operating Modes

### 2.1. Voltage Measurement

A re-configurable voltage divider automatically provides a suitable range in voltage measurement mode. The following table summarizes the full-scale ranges in each configuration.

Configuration	Full Scale Range	Divider Ratio	Resister Connection
<sup>1</sup> VR1	660.0mV	1	VR1 (10MΩ)
VR2	6.600V	1/10	VR2 (1.111MΩ)
VR3	66.00V	1/100	VR3 (101KΩ)
<sup>2</sup> VR4	660.0V	1/1000	VR4 (10.01KΩ)
VR5	1000V	1/10000	VR5 (1KΩ)

Note:

1. 660.0mV range only exists in manual mode.
2. If VST (pin113) is set to V- level, the auto range mode will start from 660.0V range.  
660.0mV – 66.00V ranges only exist in manual mode

#### 2.1.2 CE selection

ES51965 has a CE selection feature archived by configuring the pin CESEL. In automatic voltage mode, ES51965 will show OL when the voltage is over than the overflow level. If CESEL is connected to V- or DGND, ES51965 will have a 610.0V or 1010V overflow level in voltage mode relatively. If CESEL keeps floating, the overflow level will be set to 1510V in DCV and ACV mode. The configuration of CESEL is listed below.

For fully automatic voltage modes:

CESEL	DCV	ACV
floating	1510V	1010V
V-	610V	610V
DGND	1010V	1010V



## 2.2 Resistance Measurement

A re-configurable divider automatically provides a suitable full-scale range in resistance measurement mode. The following table summarizes the full-scale ranges and the reference resistors in each configuration. When the function code is set to FC1~5=(0,1,0,1,0), ES51965 enters the resistance mode for clampmeter. It only has 3 ranges from 660.0Ω to 66.00KΩ.

Configuration	Full Scale Range	Relative Resistor	Equivalent value
OR1	660.0Ω	OR1	100Ω
OR2	6.600KΩ	VR5	1KΩ
OR3	66.00KΩ	VR4    VR1	10KΩ
OR4	660.0KΩ	VR3    VR1	100KΩ
OR5	6.600MΩ	VR2    VR1	1MΩ
OR6	66.00MΩ	VR1	10MΩ

## 2.3 Current measurement for multimeter

ES51965 has 2 automatic and 1 manual current measurement modes for multimeter. The following table summarizes the full-scale range of each mode. When ES51965 operates in the current measurement modes for multimeter, it takes high input from pin IVSH or IVSL, low input from pin SGND with full scale 66mV and reference voltage from pin VR (-400mV).

Mode	FC1~4	VBAR	Full Scale	Input Terminal
Automatic1	1,1,0,1	1	660.0μA / 6600μA	IVSL/IVSH V.S. SGND (66mV)
Automatic2	1,1,1,1	1	66.00mA / 660.0mA	IVSL/IVSH V.S. SGND (66mV)
Manual	0,0,0,0	X	66.00A	IVSH V.S. SGND (66mV)

Note:

1. Connect VBAR to V- will disable the “μ<sub>2</sub>” / ”m<sub>2</sub>” symbol on LCD panel.

## 2.4 Current measurement for clampmeter

ES51965 has 2 automatic and 4 manual current measurement modes for Clampmeter. The following table summarizes the full-scale range of each mode. When ES51965 operate in the automatic mode1&2, it takes high input from IVSH/IVSL (higher range/lower range), low input from SGND with full scale 66mV and reference voltage from VR. When ES51965 operates in the manual mode1~4, it takes high input from ADP, low input from SGND with full scale 660mV and reference voltage from VA+ and VA-.

Mode	FC1~4	<sup>1</sup> VBAR	Full Scale	Input Terminal
Automatic1	1,1,0,1	0	660.0A / 6600A	IVSL/IVSH V.S. SGND (66mV)
Automatic2	1,1,1,1	0	66.00A / 660.0A	IVSL/IVSH V.S. SGND (66mV)
Manual1	1,1,0,0	X	6.600A	ADP V.S. SGND (660mV)
Manual2	1,0,0,0	X	66.00A	ADP V.S. SGND (660mV)
Manual3	1,0,1,0	X	660.0A	ADP V.S. SGND (660mV)
Manual4	1,0,0,1	X	6600A	ADP V.S. SGND (660mV)

Note:

1. Connect VBAR to V- will disable the “ $\mu_2$ ” / ”m<sub>2</sub>” symbol on LCD panel..
2. In DC current modes for clampmeter, ES51965 provides **Zero function** for offset removing.

## 2.5 Low pass filter (LPF) mode for ACA/ACV mode

A 3<sup>rd</sup> order low-pass filter with is built in ES51965. The LPF mode is active automatically when the input AC frequency of voltage or current is less than 500Hz. That means if the frequency is lower, the LPF mode (3dB BW = 7.5kHz typ.) will be helpful to filter-out the high frequency noise of the main signal. When LPFOFF (pin 114) is pulled to V-, the LPF mode will be disabled always. When PEAK mode is active, the auto LPF mode will be disabled temporarily until the PEAK mode is inactive.



## 2.6 Capacitance Measurement

The following table summarizes the eight ranges of capacitance measurement mode.

Configuration	Full Scale Range	Relative Resistor	Measurement Period
C1	6.600nF	-	0.35 sec
C2	66.00nF	50k VR <sup>3</sup>	0.35 sec
C3	660.0nF	101kΩ	0.35 sec
C4	6.600uF	10.01kΩ	0.35 sec
C5	66.00uF	R9K / R1K	0.7 sec
C6	660.0uF	R9K / R1K	1.4 sec
C7 <sup>4</sup>	6.600mF	R9K / R1K	1.4 sec
C8 <sup>4</sup>	66.00mF	R9K / R1K	7.0 sec

Note:

1. In order to obtain an accurate reading, a capacitor must be discharged before measurement begins. The chip has a built-in discharge mode to automatically discharge the capacitor. In discharge mode, the main-display shows **dIS.C**
2. Discharging through the chip is quite slow. We recommend users to discharge the capacitor with some other apparatus.
3. The C2 range is calibrated by the VR near to the OVX pin.
4. The C1 range zero offset could be compensated by the small capacitors near to OVH pin.
5. When capacitance measurement (Clamp mode) is selected, C7-C8 range measurement period will be double.

## 2.7 Continuity Check

Continuity check shares the same configuration with 660.0Ω manual resistance measurement mode and has buzzer output to indicate continuity. The buzzer generates 2KHz beep whenever the reading is less than 30Ω.

## 2.8 Diode Measurement

Diode measurement mode shares the same configuration with 6.600V manual voltage measurement mode and has buzzer output to indicate continuity. The buzzer generates a 2KHz sound whenever the reading is less than 30mV. If the test circuit is open or the voltage drop between the two ports of the device (diode) under test is larger than 2V, the LCD panel will show “OL”.

## 2.9 Frequency counter

In frequency mode, main-display shows frequency and sub-display shows duty cycle at the same time. The time base of the frequency counter is derived from an external crystal oscillator by

$$T_{\text{counter}} = \frac{4,000,000}{F_{\text{osc}}}$$

where  $F_{\text{osc}}$  is the frequency of the crystal oscillator. Thus, the counter has a 1-second time base when a 4MHz oscillator is used. The frequency counter can select the proper range automatically or manually. Auto-range operation extends over seven decades, from 66.00Hz to 66.00MHz. The following table summarizes the full-scale range of the frequency counter.

Range	Full Scale
FR1*	66.00Hz
FR2	660.0Hz
FR3	6.600KHz
FR4	66.00KHz
FR5	660.0KHz
FR6	6.600MHz
FR7	66.00MHz

\*If input frequency is less than 6.0Hz, ES51965 will show **0.00Hz**

## 2.10 Temperature measurement mode

Temperature measurement mode takes input signal from ADP pin and reference voltage from (VA+ - VA-). ES51965 has a built-in °C-to-°F scale translation circuit, and only needs an external °C scale application circuit. The application circuit for °F scale is not required. In temperature measurement mode, the default range is 6600 °C or 9999 °F. The VBAR pin is used to control the first decimal point (DP1) on the LCD panel. When VBAR is pulled to V-, DP1 will be turned on and the full scale becomes 660.0 °C or 999.9 °F.

## 2.11 Duty Cycle measurement

The duty cycle measurement is available in frequency mode simultaneously. The duty cycle mode range is within 1.00 to 98.90% (< 10kHz@3Vpp). The minimum resolution is 0.01%. If the source frequency duty cycle is smaller than 0.9%, the 0.00% will be shown on the LCD display. If the duty cycle is larger than 98.9%, the **OL** will be shown on the LCD sub-display. If the SHIFT pin (pin 111) is pull to V-, a display shifted feature is available for duty-cycle mode. The minimum resolution is 0.1% when SHIFT is active. When the frequency input is zero, the duty cycle display will be 0.00% or OL shown.



### **2.12 Auto power off and idle time selection**

ES51965 has a default auto power off function. If the meter is idle for more than the given Idle Time, the chip automatically turns the power off. The idle time to trigger the auto power off function is determined by pin 'APOSEL'. If pin APOSEL is connected to V-, the Idle Time will be set to 30 minutes. If pin APOSEL is connected to DGND or floating, the Idle Time will be set to 15 minutes. When APO happens, the state of the meter is saved. The APO sign on the LCD panel indicates whether the auto power off is enabled or not. In some cases, user might want to disable Auto power off. There are two ways to disable this feature as following:

1. Power on the meter when any of the push functions, except for HOLD, is pressed down.
2. In addition, when RS232 output is active, the auto power off function is also disabled.

**Note:** Powering on the meter while pressing HOLD and lasts 2 seconds turns on all LCD segments until HOLD is pressed again.

### **2.13 Sleep**

The meter enters sleep mode after auto power off. The SLEEP pin asserts low (V-) in the sleep mode, and asserts high (V+, not 0V) after re-power on.

### **2.14 Re-power on**

After auto power-off, pushing any of the push function or changing the rotary mode can turn on the meter again. If the meter is re-powered on by changing the rotary mode, the saved state is cleared. If the meter is re-powered on by push functions, the chip restores the saved state and enters HOLD mode. The LCD displays the saved value.

### 3. Measurement Mode Switching

Measurement mode depends on the logic level of SLACDC, FC1, FC2, FC3, FC4, FC5, and KEY. When FC5 is high, the measurement mode list is below.

SLACDC	FC1	FC2	FC3	FC4	Mode	Function of KEY
0	1	0	1	1	Voltage Measurement	DCV ↔ ACV
0	1	1	0	1	<sup>12</sup> Auto DC Current Measurement(μA)	DCA ↔ ACA
0	1	1	1	1	<sup>12</sup> Auto DC Current Measurement(mA)	DCA ↔ ACA
0	0	0	0	0	<sup>1</sup> 66A DC Current Measurement(A)	DCA ↔ ACA
X	1	1	1	0	—	—
0	1	1	0	0	<sup>2</sup> Manual DC 6.600A	DCA ↔ ACA
0	1	0	0	0	<sup>2</sup> Manual DC 66.00A	DCA ↔ ACA
0	1	0	1	0	<sup>2</sup> Manual DC 660.0A	DCA ↔ ACA
0	1	0	0	1	<sup>2</sup> Manual DC 6600A	DCA ↔ ACA
0	0	0	1	1	Resistance Measurement	Ω ↔ Continuity
0	0	0	0	1	Continuity Check	Continuity ↔ Diode
0	0	1	1	1	Resistance Measurement	Ω ↔ Continuity ↔ Diode
0	0	0	1	0	Frequency Measurement	—
0	0	1	1	0	Capacitance Measurement	—
0	0	1	0	0	Temperature Measurement	°C ↔ °F
1	1	0	1	1	Voltage Measurement	ACV ↔ DCV
1	1	1	0	1	<sup>12</sup> Auto AC Current Measurement(μA)	ACμA ↔ DCμA
1	1	1	1	1	<sup>12</sup> Auto AC Current Measurement(mA)	ACmA ↔ DCmA
1	0	0	0	0	<sup>1</sup> 66A AC Current Measurement(A)	ACA ↔ DCA
1	1	1	0	0	<sup>2</sup> Manual AC 6.600A	ACA ↔ DCA
1	1	0	0	0	<sup>2</sup> Manual AC 66.00A	ACA ↔ DCA
1	1	0	1	0	<sup>2</sup> Manual AC 660.0A	ACA ↔ DCA
1	1	0	0	1	<sup>2</sup> Manual AC 6600A	ACA ↔ DCA
1	0	0	1	1	*ADP0 (6600)	—
1	0	0	0	1	*ADP1 (660.0)	—
1	0	1	1	1	*ADP2 (66.00)	—
1	0	0	1	0	*ADP3 (6.600)	—
1	0	1	1	0	Capacitance Measurement (Clamp) <sup>3</sup>	—
1	0	1	0	0	Temperature Measurement	°F ↔ °C
X	0	1	0	1	Resistance Measurement	Ω ↔ Diode

X means “don’t care”.

\*When FC5 is high, the ADP0, ADP1, ADP2 and ADP3 modes can display minus sign.

<sup>1</sup>These modes could be designed for multimeter current modes, please refer to section 2.3.

<sup>2</sup>These modes could be designed for clampmeter current modes, please refer to section 2.4.

<sup>3</sup>The external protection resistance of OVH path is allowed to be 2kΩ PTC + max 2kΩ fixed resistor. The OVX capacitor 220pF → 1nF should be used.

When FC5 is low, the KEY function is disable. The measurement mode list is below.

SLACDC	FC1	FC2	FC3	FC4	Mode	KEY
0	1	0	1	1	DC Voltage Measurement	—
0	1	1	0	1	<sup>12</sup> Auto DC Current Measurement( $\mu$ A)	—
0	1	1	1	1	<sup>12</sup> Auto DC Current Measurement(mA)	—
0	0	0	0	0	<sup>1</sup> 66A DC Current Measurement(A)	—
X	1	1	1	0	—	—
0	1	1	0	0	<sup>2</sup> Manual DC 6.600A	—
0	1	0	0	0	<sup>2</sup> Manual DC 66.00A	—
0	1	0	1	0	<sup>2</sup> Manual DC 660.0A	—
0	1	0	0	1	<sup>2</sup> Manual DC 6600A	—
0	0	0	1	1	Resistance Measurement	—
0	0	0	0	1	Continuity Check	—
0	0	1	1	1	Diode Measurement	—
0	0	0	1	0	Frequency Measurement	—
0	0	1	1	0	Capacitance Measurement	—
0	0	1	0	0	Temperature Measurement ( $^{\circ}$ C)	—
1	1	0	1	1	AC Voltage Measurement	—
1	1	1	0	1	<sup>12</sup> Auto AC Current Measurement( $\mu$ A)	—
1	1	1	1	1	<sup>12</sup> Auto AC Current Measurement(mA)	—
1	0	0	0	0	<sup>1</sup> 66A AC Current Measurement(A)	—
1	1	1	0	0	<sup>2</sup> Manual AC 6.600A	—
1	1	0	0	0	<sup>2</sup> Manual AC 66.00A	—
1	1	0	1	0	<sup>2</sup> Manual AC 660.0A	—
1	1	0	0	1	<sup>2</sup> Manual AC 6600A	—
1	0	0	1	1	*ADP0 (6600)	—
1	0	0	0	1	*ADP1 (660.0)	—
1	0	1	1	1	*ADP2 (66.00)	—
1	0	0	1	0	*ADP3 (6.600)	—
1	0	1	1	0	Capacitance Measurement (Clamp) <sup>3</sup>	—
1	0	1	0	0	Temperature Measurement ( $^{\circ}$ F)	—
X	0	1	0	1	<sup>4</sup> Resistance Measurement (Clamp)	—

X means “don’t care”.

\*When FC5 is low, the ADP0, ADP1, ADP2 and ADP3 modes can **NOT** display minus sign.

<sup>1</sup>These modes could be designed for multimeter current modes, please refer to section 2.3.

<sup>2</sup>These modes could be designed for clampmeter current modes, please refer to section 2.4.

<sup>3</sup>The external protection resistance of OVH path is allowed to be 2k $\Omega$  PTC + max 2k $\Omega$  fixed resistor. The OVX capacitor should be modified from 220pF  $\rightarrow$  1nF.

<sup>4</sup>This mode has 3 ranges only from 660.0 $\Omega$ (with continuity check) to 66.00K $\Omega$ .

#### 4. Push function

All the enabled push functions will be reset when the measurement mode is changed by rotary switch. Change measurement mode by KEY function will reset enabled Range, Hold, Max/Min, REL, PEAK-hold and Zero functions. The following table lists the available function versus every measurement mode.

Function Mode	Range	Hold	Max/Min	REL	PEAK	Zero
Voltage	O	O	O	O	AC	X
<sup>1</sup> Current Mode for Multimeter	O	O	O	O	AC	X
<sup>2</sup> Current Mode for Clampmeter	O	O	O	AC	AC	DC
Resistance	O	O	O	O	X	X
Frequency	O	O	X	X	X	X
Capacitance	O	O	O	O	X	X
Continuity	X	O	O	O	X	X
Diode	X	O	O	O	X	X
Temperature	X	O	O	O	X	X
ADP	X	O	O	O	O <sup>3</sup>	X

Note:

<sup>1</sup>Include automatic  $\mu$ A, automatic mA and manual 66A modes, please refer to **section 2.3**.

<sup>2</sup>Include 2 automatic modes and 4 manual modes, please refer to **section 2.4**.

<sup>3</sup>When FC5=0, Peak-hold function is not available for ADP mode.

#### 4.1. HOLD and Delay Hold feature

HOLD mode makes the meter stop updating the LCD panel. This mode can be nested in most of the special modes. Enabling HOLD function in automatic mode makes the meter switch to manual mode, but the full-scale range remains the same. ES51965 provides a Delay HOLD feature. To activate Delay HOLD feature, press down the HOLD bottom and last for 2 seconds. The meter will delay for 6 seconds, than enters HOLD mode. In the 6-second delayed time, the HOLD symbol on LCD panel will blink. HOLD function and the delayed state can be cancelled by changing the measurement mode, pressing RANGE, or push HOLD again.



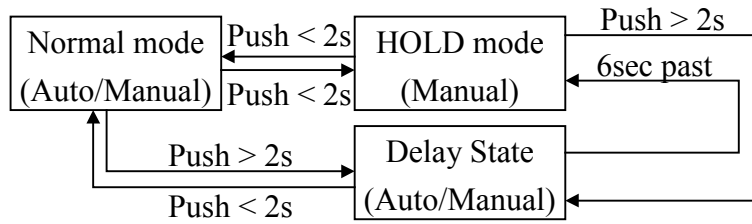

#### 4.2. Range

RANGE pin switches to and from automatic and manual mode, and while in manual mode, changes the full-scale range. The following figure shows the state transition.

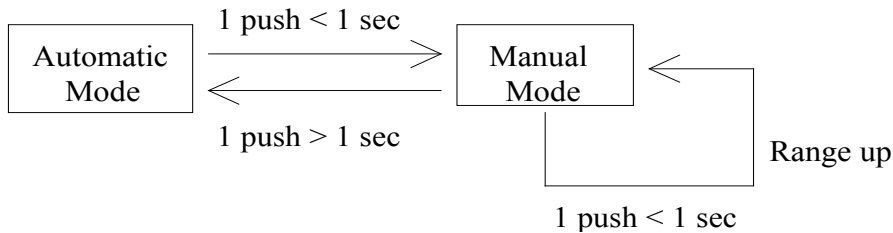

Measurement Mode	Auto	Manual	Control Range	Initial Range
V(DC/AC)	VR2 – VR5	VRi → VRi + 1, VR5 → VR1	660.0mV – 1000V	6.600V
Auto μA(DC/AC)	R1 – R2	R1 → R2, R2 → R1	660.0μA – 6600μA	660.0μA
Auto mA(AC/DC)	R1 – R2	R1 → R2 R2 → R1	66.00mA – 660.0mA	66.00mA
66 A(DC/AC)	fixed	fixed	66.00A	66.00A
Auto 66A/660A (DC/AC)	R1 – R2	R1 → R2 R2 → R1	66.00A – 660.0A	66.00A
Auto 660A/6600A (DC/AC)	R1 – R2	R1 → R2 R2 → R1	660.0A – 6600A	660.0A
Capacitance	C1 – C8	Ci → Ci + 1, C8 → C1	6.600nF– 66.00mF	6.600nF
Ω	OR1 – OR6	ORi → ORi + 1, OR6 → OR1	660.0Ω – 66.00MΩ	660.0Ω
Ω (Clamp)	OR1 – OR3	ORi → ORi + 1, OR3 → OR1	660.0Ω – 66.00KΩ	660.0Ω
Continuity	fixed	fixed	660.0Ω	660.0Ω
Diode	fixed	fixed	6.600V	6.600V
Frequency	FR1 – FR7	FRi → FRi + 1 FR7 → FR1	66.00Hz – 66.00MHz	66.00Hz

Note: Pushing RANGE resets all existing special modes.

#### 4.3. KEY

See Section “Measurement Mode Switching” for the function of this pin.



#### 4.4. REL + HOLD

In REL mode, the main-display shows  $D_{N+K} - D_N$ (relative value), where  $N = 1, 2, 3, \dots$ , and the  $D_N$  value is shown on sub-display.  $D_N$ (reference value) is the last value before REL is pushed, and  $D_{N+K}$  is the current value. The meter returns to normal operation if REL is pressed again. Pressing HOLD in REL mode makes the meter stop updating the LCD panel.

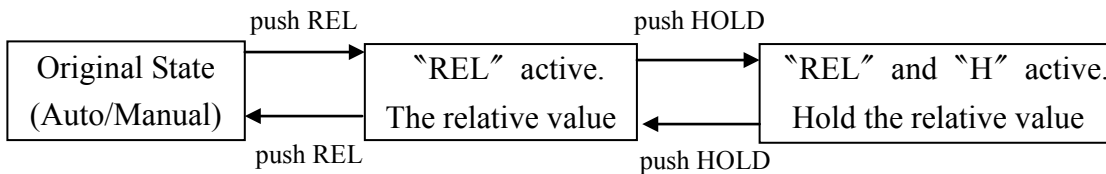

Note: It's possible that relative value exceeds 6,600 or -6,600 counts, but never exceeds 9,999 or -9,999 counts. Such relative values are displayed. The LCD shows OL in REL mode only if  $D_N$  or  $D_{N+K}$  is more than 6,600 counts or the relative value is more than 9,999.

#### 4.5. Max/Min + HOLD

The meter displays maximum or minimum value of input in Max/Min mode. When Max/Min is pressed for the first time, sub-display shows maximum value. Sub-display shows minimum value, when it is pressed again. Main-display always shows current value in Max/Min mode. The meter returns to normal operation if Max/Min is pressed and held for longer than one second. Pressing HOLD in Max/Min mode makes the meter stop updating the maximum or the minimum value.

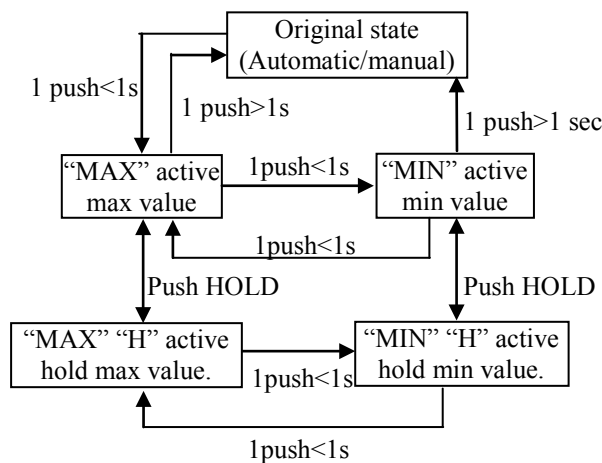



**4.6. Relative + Max/Min + HOLD**

Max/Min mode can be nested in REL mode. Sub-display shows maximum or minimum value which is relative to the reference and shows the reference value when Max/Min is pressed in REL mode. Main-display always shows current relative value. Pressing HOLD under REL + Max/Min makes the meter stop updating the LCD panel.

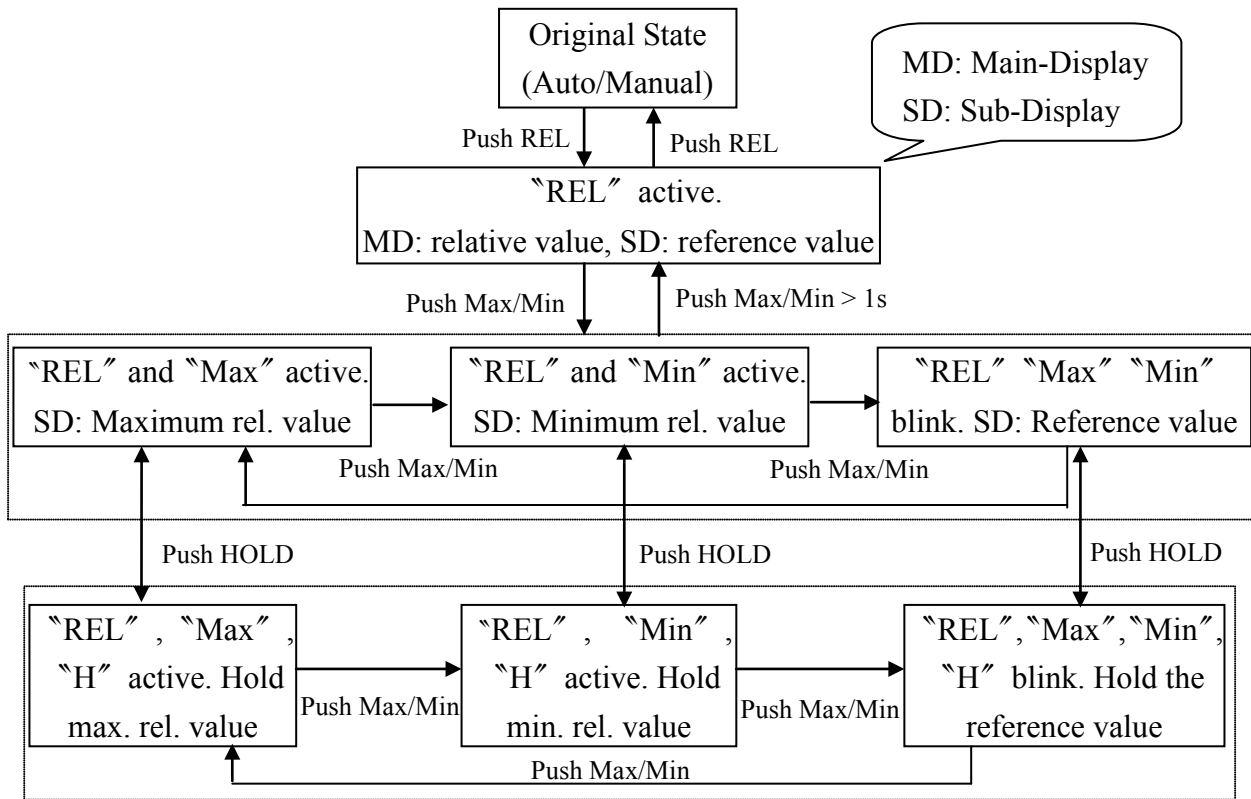

**4.7. PEAK-HOLD function**

ES51965 provides Peakhold function to capture the maximum or minimum peak value. To enter peak mode, press PEAK key less than 1 second. A self-calibration process will execute automatically before normal peak-hold operation. The precision of Peak mode measurement can be enhanced by calibration. In peak mode, main-display shows current value of signal, and sub-display shows PMAX or PMIN value which is selected by PEAK input. Peak mode takes from input PMIN or PMIN pin. The peak values are stored in external capacitors. Polyester capacitors are recommended. To exit PEAK-hold function, press PEAK key larger than 1 seconds.

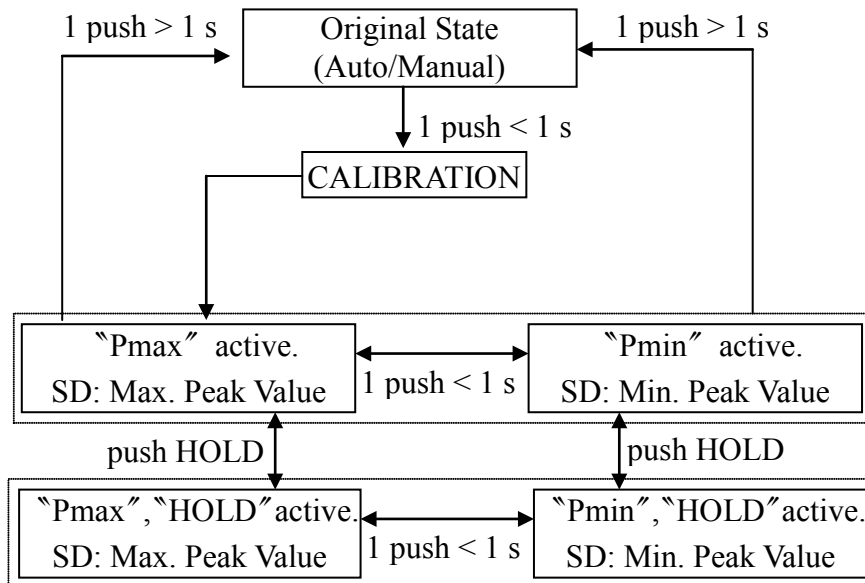

#### 4.8. ZERO function

In manual DC 6.600A, 66.00A, 660.0A and 6600A, auto DC 66.00A/660.0A and auto DC 660.0A/6600A measurement modes, ES51965 provides Zero function to remove the residual current value. Push ZERO bottom less than one second to enter Zero mode. In Zero mode, main-display shows  $D_{N+K} - D_N$ , where  $N = 1, 2, 3, \dots$ ,  $D_N$  is the last conversion value before Zero is pushed, and  $D_{N+K}$  is the current conversion value. Sub-display shows nothing if no other function is activated. If Zero is pushed again in Zero mode, main-display will update the  $D_N$  value and displays the  $D_{N+K} - D_N$  again. The meter returns to normal operation if Zero is pressed and held for longer than one second. Pressing HOLD in Zero mode makes the meter stop updating the LCD panel. In 2-range auto DCA modes for clampmeter (660.0A/6600A or 66.00A/660.0A), the system will stay in automatic mode, even if the Zero function is activated. In other words, it could achieve real automatic operation. In automatic mode, Zero function could not be entered from higher range, but it could be still activated if current range is lower one. This is because most residual current value is so small that the range should stay at lower one in automatic mode. When enter Zero mode from lower range, the system will store the nonzero counts (residual current value). If the range goes up to higher one automatically, the non-zero counts will be divided by ten. So this function will still work well in automatic modes.



State diagram for Zero mode:

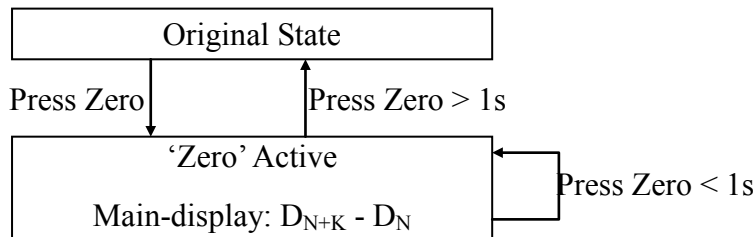

State diagram for Zero + HOLD mode:

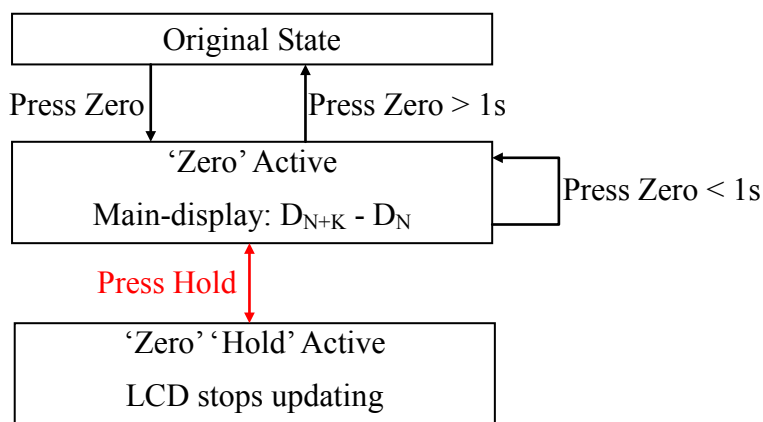

State diagram for Zero + Max/Min + HOLD mode:

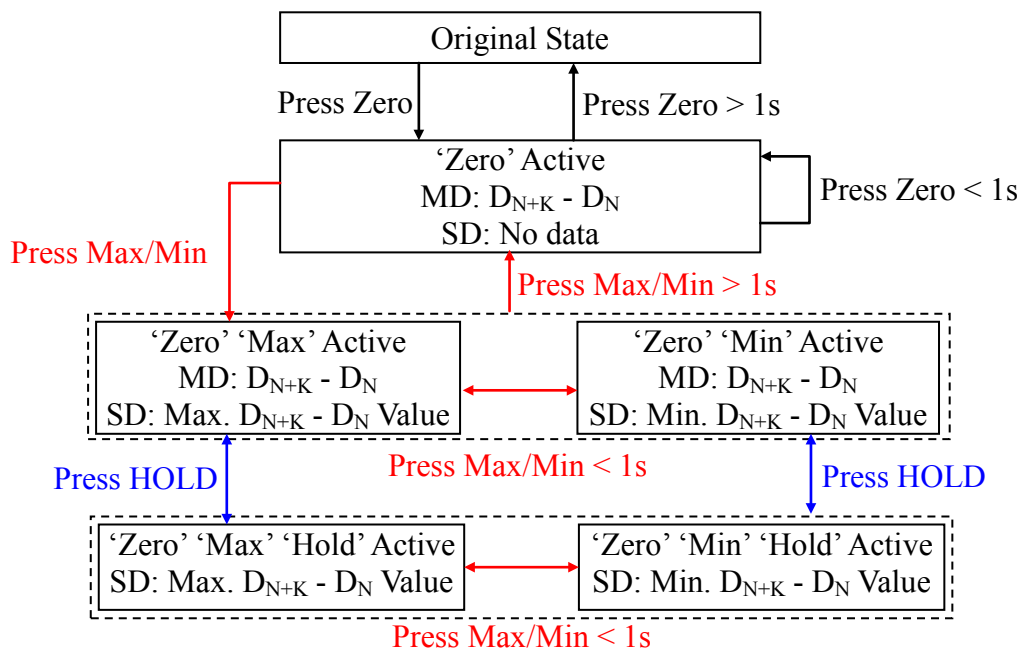

### 5. Serial Data Output

The RS232 function will be activated if the RS232 pin is pulled to and asserts at V-. The serial data sent to **SDO** pin once every A/D conversion cycle. The data format complies with JIS 7Bits transmission code with a baud rate of 19230. The host can use RS232 interface to read the data. A single data packet includes a start bit (always 0), 7 data bits, an odd parity check bit, and a stop bit (always 1). The high and low voltage levels correspond to DGND and V- respectively. SDO remains at 1 (high) when it is inactive. Hence the start bit (0) could be used as the triggering signal to begin the reading process. The following figure shows the data format of a single packet. The LSB is sent first and the MSB is sent last.

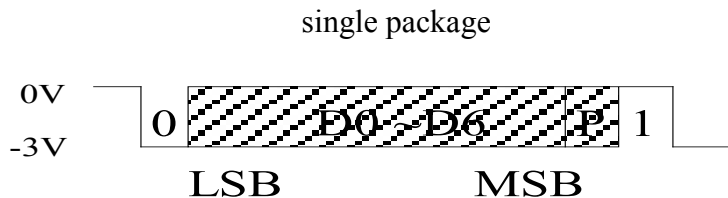

One data block consists of 17 packets, or 170 bits. The following figure shows the format of a data block. The **M\_range** or **S\_range** packet indicates the full-scale range of main measurement mode or sub-measurement mode. **M\_digit3** through **M\_digit0** are the conversion result of main measurement mode, and **S\_digit3** through **S\_digit0** are the conversion result of sub-measurement mode(Hz or duty). The function packet indicates the measurement mode of the meter. Status, option1, option2 and option3 give the status of the meter. CR and LF are delimiters used to separate the blocks.

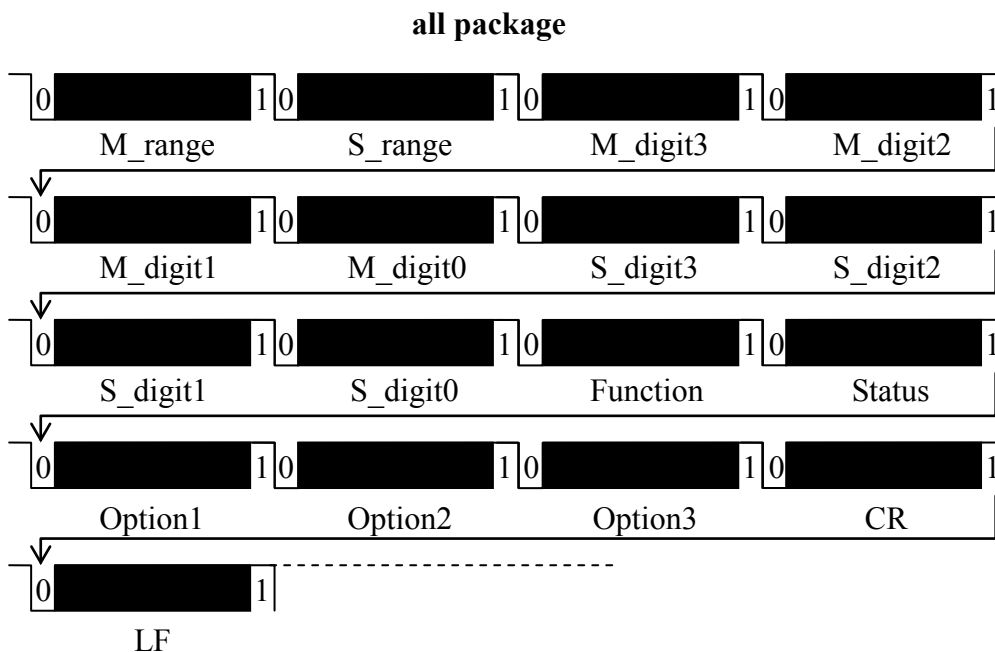



### 5.1. FUNCTUON

This packet indicates the measurement mode of the meter. The following table summarizes the transmitted code for each mode. Note that the encoding of this packet is different from the encoding of FC1-FC5 switch.

Code	Measurement Mode	VBAR=0	VBAR=1
0111011	Voltage	Don't care	
<sup>2</sup> 0111101	Auto $\mu$ A Current	Auto $\mu$ A Current	Auto 660.0A/6600A
<sup>2</sup> 0111111	Auto mA Current	Auto mA Current	Auto 66.00A/660.0A
0110000	66 A current	Don't care	
0111001	Manual A Current		
0110011	$\Omega$		
0110101	Continuity		
0110001	Diode		
0110010	Frequency		
0110110	Capacitance		
0110100	<sup>1</sup> Temperature		
0111110	ADP		

<sup>1</sup>When the function code = 0110100, the TF bit in the Status packet determines whether the unit is Celsius or Fahrenheit.

<sup>2</sup>When the function code = 0111101 or 0111111, the measurement mode is determined by VBAR bit of STATUS packet.

### 5.2. RANGE

This packet indicates the full-scale range of the meter. When the meter operates in continuity mode or diode mode, this packet is always 0110000 since the full-scale ranges in these modes are fixed. The following table lists the code for each range in each measurement mode.

Code	V	*2-range auto A	66 A	Manual A	ADP	$\Omega$	Frequency	Capacitor
0110000	6.600V	Lower Range(IVSL)	66.00 A	6.600A	ADP3	660.0 $\Omega$	66.00Hz	6.600nF
0110001	66.00V	Higher Range(IVSH)		66.00A	ADP2	6.600K $\Omega$	660.0Hz	66.00nF
0110010	660.0V			660.0A	ADP1	66.00K $\Omega$	6.600KHz	660.0nF
0110011	1000V			6600A	ADP0	660.0K $\Omega$	66.00KHz	6.600 $\mu$ F
0110100	660.0mV					6.600M $\Omega$	660.0KHz	66.00 $\mu$ F
0110101						66.00M $\Omega$	6.600MHz	660.0 $\mu$ F
0110110							66.00MHz	6.600mF
0110111								66.00mF

\*It includes auto 660.0/6000 $\mu$ A, 66.00/660.0mA, 66.00A/660.0A, 660.0A/6000A.



### 5.3. Mdigit\_3 – Mdigit\_0 and Sdigit\_3 – Sdigit\_0

Mdigit\_3 – Mdigit\_0 is the measurement result of main measurement mode. This result is shown on main-display of LCD panel. Sdigit\_3 – Sdigit\_0 is the measurement result of sub-measurement mode, for example, frequency in AC voltage/current mode or duty cycle in frequency mode. This result will be shown on sub-display of LCD panel. Mdigit3 and Sdigit3 is the most significant digit, and Mdigit0 and Sdigit0 is the least significant digit.

Digit	Code
0	0110000
1	0110001
2	0110010
3	0110011
4	0110100
5	0110101
6	0110110
7	0110111
8	0111000
9	0111001

### 5.4. STATUS

The format of this package is shown below. The TF field is meaningful only when the Function packet indicates Temperature mode. In Temperature mode, the TF is 1 if the unit is °C and is 0 if the unit is °F. BATT field is one when battery low condition is true. The Judge bit is available in duty cycle mode. If the Judge bit is 1, the final result should be calculated by  $(100-X) \%$  which **X** is the output data from Sdigit\_3~Sdigit0. If the Judge bit is 0, then the final data is **X** %. The VBAR will be 1 only when the VBAR pin is connected to V-.

0	1	1	TF	BATT	Judge	VBAR
BIT6	BIT 5	BIT 4	BIT 3	BIT 2	BIT1	BIT 0





### 5.5. OPTION 1

DC field indicates that the meter operates in DC measurement mode, either voltage or current. AC field indicates that the meter operates in AC measurement mode, either voltage or current. AUTO field is set to 1 if the meter operates in automatic mode, and is set to 0 when the meter operates in manual mode. SIGN field indicates whether the minus sign of main measurement on the LCD panel is on or off.

0	1	1	DC	AC	AUTO	SIGN
BIT 6	BIT 5	BIT 4	BIT 3	BIT 2	BIT 1	BIT 0

### 5.6. OPTION 2

0	1	1	OLM	OLS	-	-
BIT 6	BIT 5	BIT 4	BIT 3	BIT 2	BIT 1	BIT 0

OLM bit is 1 when the main measurement mode is over range. In PEAK mode, the OLM bit is active only when ADC counts larger than 9999. OLS bit is 1 when the sub-measurement mode (Hz or duty) is over range in voltage/current with frequency or frequency with duty cycle modes.

### 5.7. OPTION 3

In peak mode, the meter outputs and repeats current result, maximum peak value and minimum peak value sequentially no matter what the state of peak shown on LCD panel is PMAX or PMIN. PEAKC, PMAX or PMIN bit indicates the output data is current result of signal, or the stored voltage at the maximum peak or minimum peak capacitor. VAHz bit is set to high when the sub-display is available for HZ mode of ACV/ACA. If MAX/MIN or REL key is pushed actively, the Hz mode will be inactive and the VAHz bit will be set to low.

0	1	1	PEAKC	PMAX	PMIN	VAHz
BIT 6	BIT 5	BIT 4	BIT 3	BIT 2	BIT 1	BIT 0

### 5.8. CR

Carriage return. The transmitted code is 0001101.

### 5.9. LF

Line feed. The transmitted code is 0001010.



**6. Miscellaneous**

The conditions, which the meter turns on the buzzer, include:

- (1) Changing measurement mode generates one beep.
- (2) Pressing any of the push functions generates one beep, if the function is valid.
- (3) Power on and re-power on generate one beep.
- (4) Input overflow in voltage and current mode generates one beep every 0.3 seconds (or 3.33 beeps per second.)
- (5) Continuity(diode) check generates a continuous 2KHz beep whenever the measurement is less then  $30\Omega(30mV)$
- (6) Auto power off generates a 2KHz beep which lasts for 1.5 seconds.

The following figures show the output waveform from the BUZOUT pin.

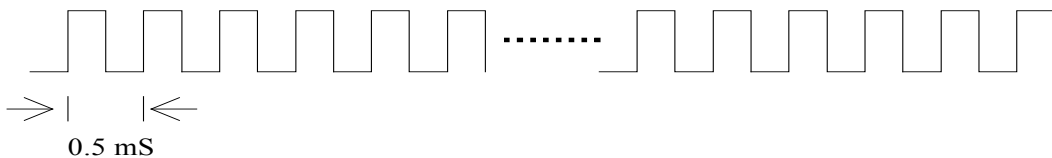

(a) Continuous 2KHz beep

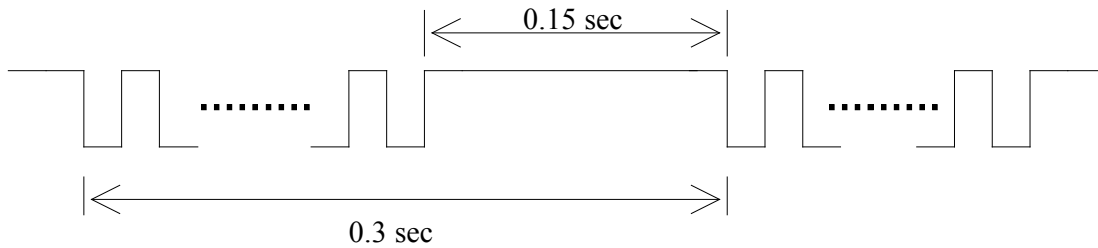

(b) 3.33 beep/sec



6.1. LCD Panel

	S01	S02	S03	S04	S05	S06	S07	S08	S09	S10	S11	S12
BP1	ADP0	ADP1	AP0	AC	MINUS	4F	4A	4B	3F	3A	3B	2F
BP2	ADP2	ADP3	RS232	LBAT	DC	4E	4G	4C	3E	3G	3C	2E
BP3	bar-	bar0	bar5 bar6	bar7 bar8	bar13 bar14	bar15 bar16	4D	DP3	bar25 bar26	3D	bar31 bar32	DP2
BP4	bar1 bar2	bar3 bar4	bar9 bar10	bar11 bar12	bar17 bar18	bar19 bar20	bar21 bar22	bar23 bar24	bar27 bar28	bar29 bar30	bar33 bar34	bar35 bar36
	S13	S14	S15	S16	S17	S18	S19	S20	S21	S22	S23	S24
BP1	2A	2B	1F	1A	1B	$\mu_2$	$m_2$	V	A	$^{\circ}C$		
BP2	2G	2C	1E	1G	1C	n	$\mu_1$	$m_1$	F	$^{\circ}F$		%
BP3	2D	bar39 bar40	DP2	1D	bar47 bar48	M	K	$\Omega$	Hz	bar59 bar60	bar61 bar62	K <sub>2</sub>
BP4	bar37 bar38	bar41 bar42	bar43 bar44	bar45 bar46	bar49 bar50	bar51 bar52	bar53 bar54	bar55 bar56	bar57 bar58	bar63 bar64	bar65 bar66	Hz <sub>2</sub>
	S25	S26	S27	S28	S29	S30	S31	S32	S33	S34		S35
BP1	S1B	S1A	S2B	S2A	S3B	S3A	S4B	S4A		AUTO		PMAX
BP2	S1G	S1F	S2G	S2F	S3G	S3F	S4G	S4F	MAX	MANU		PMIN
BP3	S1C	S1E	S2C	S2E	S3C	S3E	S4C	SMINUS	MIN	ZERO		
BP4	S1D	SDP1	S2D	SDP2	S3D	SDP3	S4D	S4E	HOLD	REL		

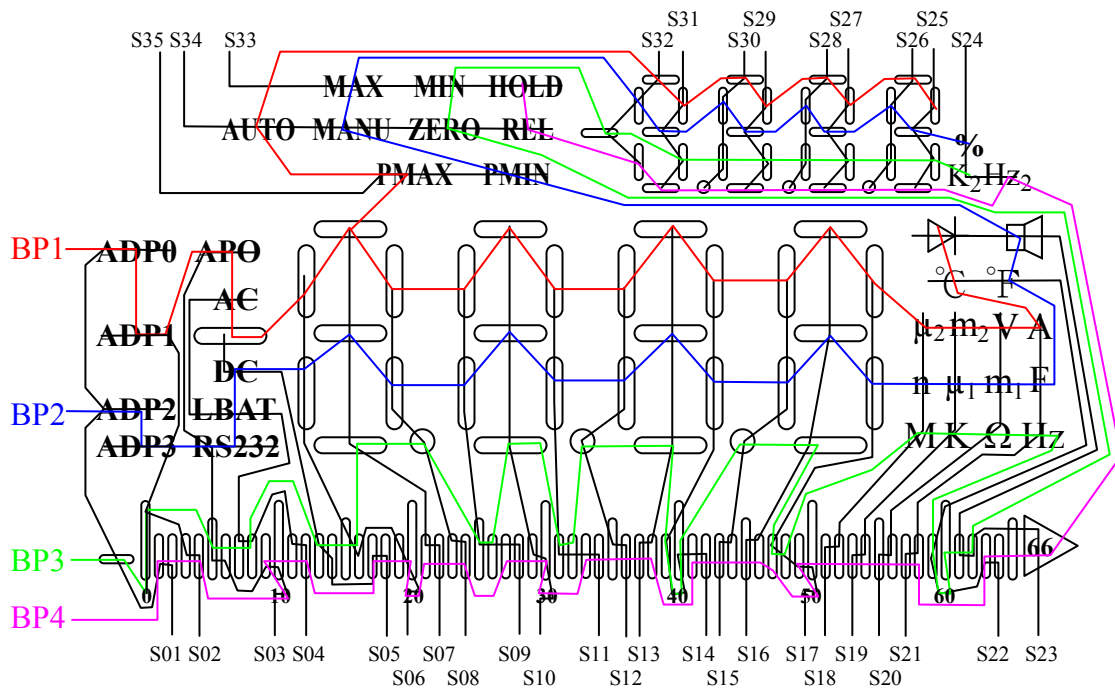



LCD Backplane Waveform

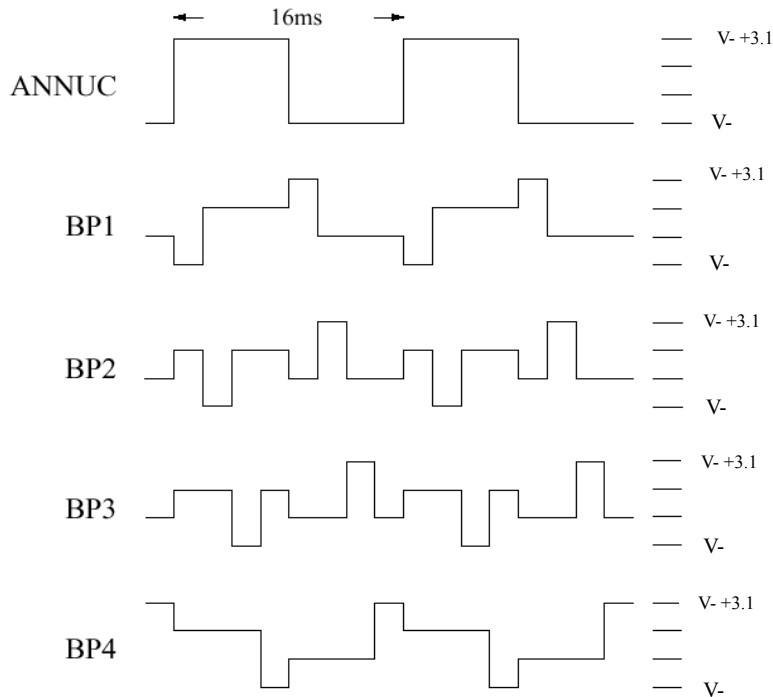

6.2. LCD display on condition

LCD Annunciator	Condition
V	In voltage measurement mode, and diode measurement mode.
A	In current measurement mode.
$\Omega$	In resistance measurement mode, and continuity mode.
F	In capacitance measurement mode.
	In continuity check mode.
	In diode mode.
%	In duty cycle measurement.
Hz	In frequency mode.
ADP1	When ADP1 mode is active
ADP2	When ADP2 mode is active
ADP3	When ADP3 mode is active
ADP4	When ADP4 mode is active
DC	In DC voltage or DC current mode.
AC	In AC voltage or AC current mode.
AUTO	When automatic full scale range selection is enabled.
MANU	In manual mode.
HOLD	When HOLD function is enabled.
REL	When Relative function is enabled.
Max / Min	When Max/Min function is enabled.
PMAX/PMIN	When PEAK-hold function is enabled.
ZERO	When ZERO function is enabled.
m <sub>1</sub>	In capacitor measurement mode and the full scale range is in the order of mF.
$\mu$ <sub>1</sub>	In capacitor measurement mode and the full scale range is in the order of $\mu$ F.
n	In capacitor measurement mode and the full scale range is in the order of nF.
m <sub>2</sub>	In voltage or current measurement mode and the full scale range is in the order of $10^{-3}$ .
$\mu$ <sub>2</sub>	In current measurement mode and the full scale range is in the order of $\mu$ A.
M	In resistance measurement mode and the full scale range is in the order of M $\Omega$



承永資訊科技  
CYRUSTEK CO.

**ES51965(6600counts)**  
**Dual Display/PEAK**

K	In resistance measurement mode and the full scale range is in the order of $K\Omega$
$^{\circ}C$	In temperature measurement mode and when the unit is $^{\circ}C$
$^{\circ}F$	In temperature measurement mode and when the unit is $^{\circ}F$
APO	When auto power off function is enabled.
RS232	When RS232 output is enabled.

### 6.3. Operating Timing

ES51965 incorporates a dual slope ADC with four phases: ZI, AZ, INT and DINT. The timing of each phase is listed below. The Bar-graph ADC is 10X faster than slow ADC.

\*Voltage / Ohm /ADP / Manual Current (for clampmeter) measurement:

Phase	Lo-speed	Hi-speed	PEAK
ZI	60ms	6ms	256ms
AZ	24ms	2.4ms	120ms
INT	100ms	10ms	100ms
DINT	166ms	16.6ms	246ms

\*Current mode for multimeter / Current mode for clampmeter

Phase	Lo-speed	Hi-speed
ZI	60ms	6ms
AZ	24ms	2.4ms
INT	1000ms	100ms
DINT	166ms	16.6ms

\*Capacitance measurement:

Range	Total Measurement Time
6.600nF	0.35sec
66.00nF	0.35sec
660.0nF	0.35sec
6.600μF	0.35sec
66.00μF	0.70sec
660.0μF	1.40sec
6.600mF	1.40sec(max)
66.00mF	7.0sec(max)

\*Frequency + Duty cycle mode measurement

In range 66.00Hz~66MHz, the measurement cycle = 1.05 sec

**P.S.** In the frequency measurement with auto mode, if the range is changed, the internal clock rate will increase ten times and the new measurement cycle becomes 1/10 times of the original cycle until the range is stable.



7. Application Circuit

7.1 AVG circuit

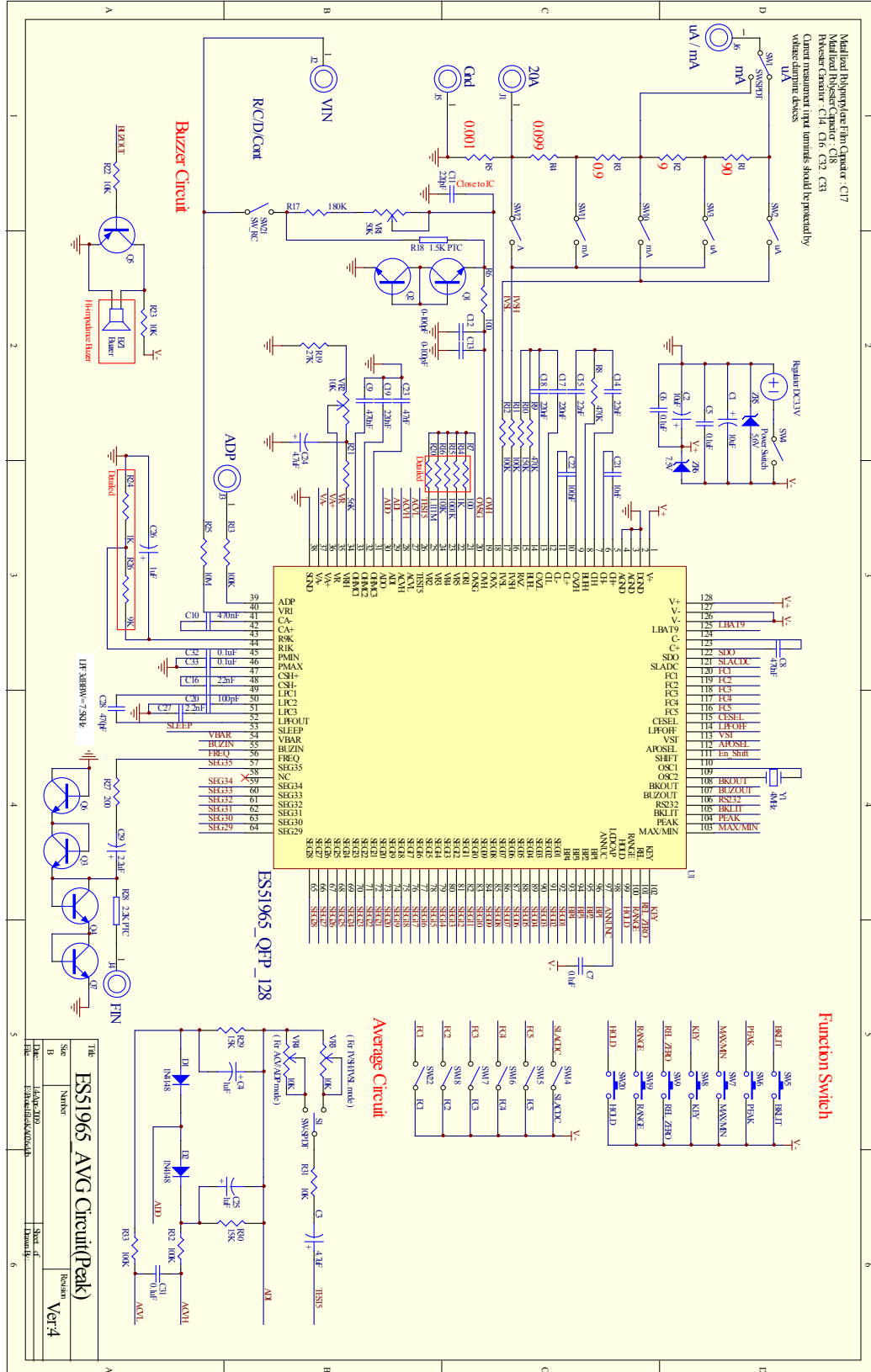



7.2 RMS circuit (ES636)

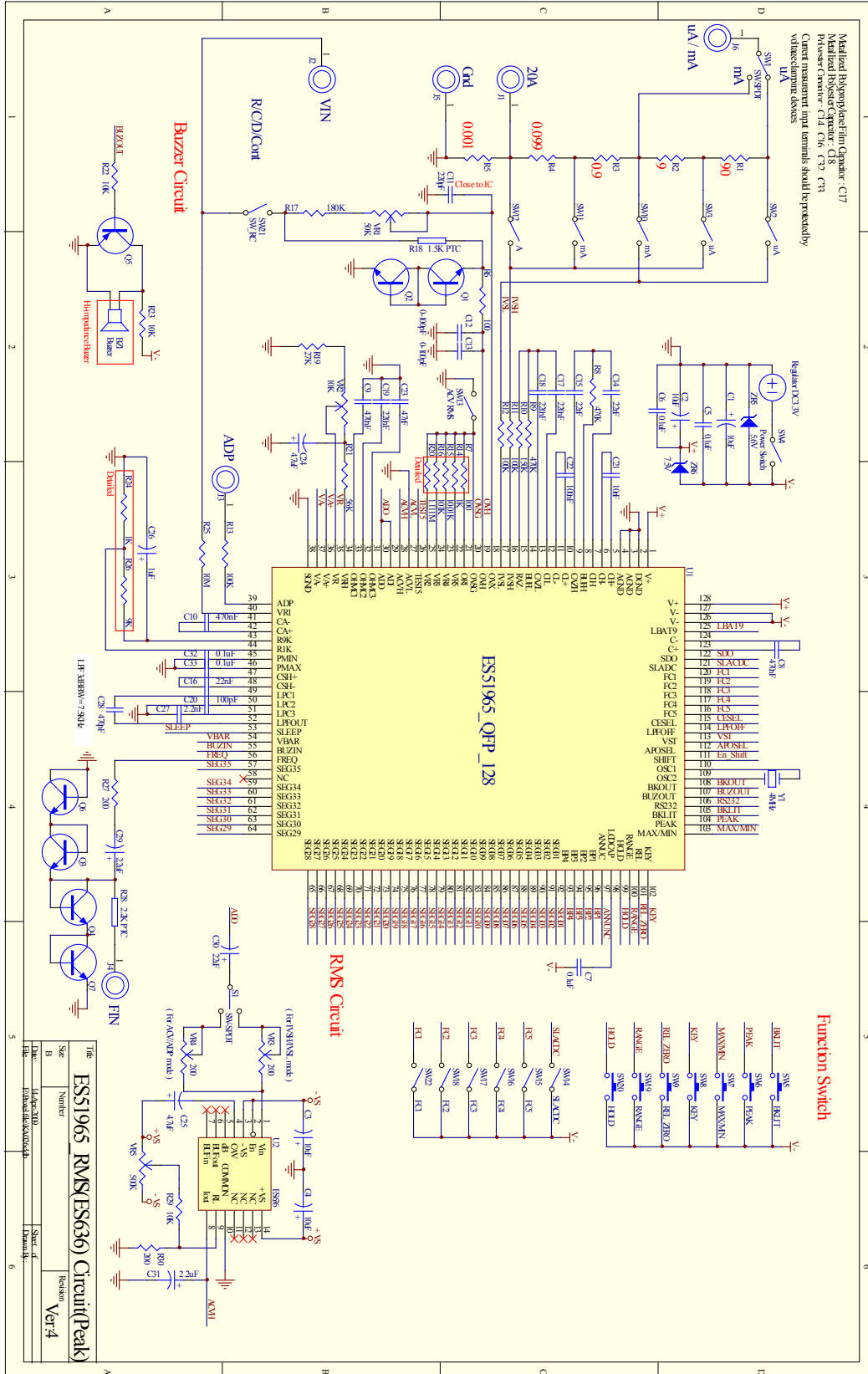





## 8. Package Information

### 8.1 128L QFP Outline drawing

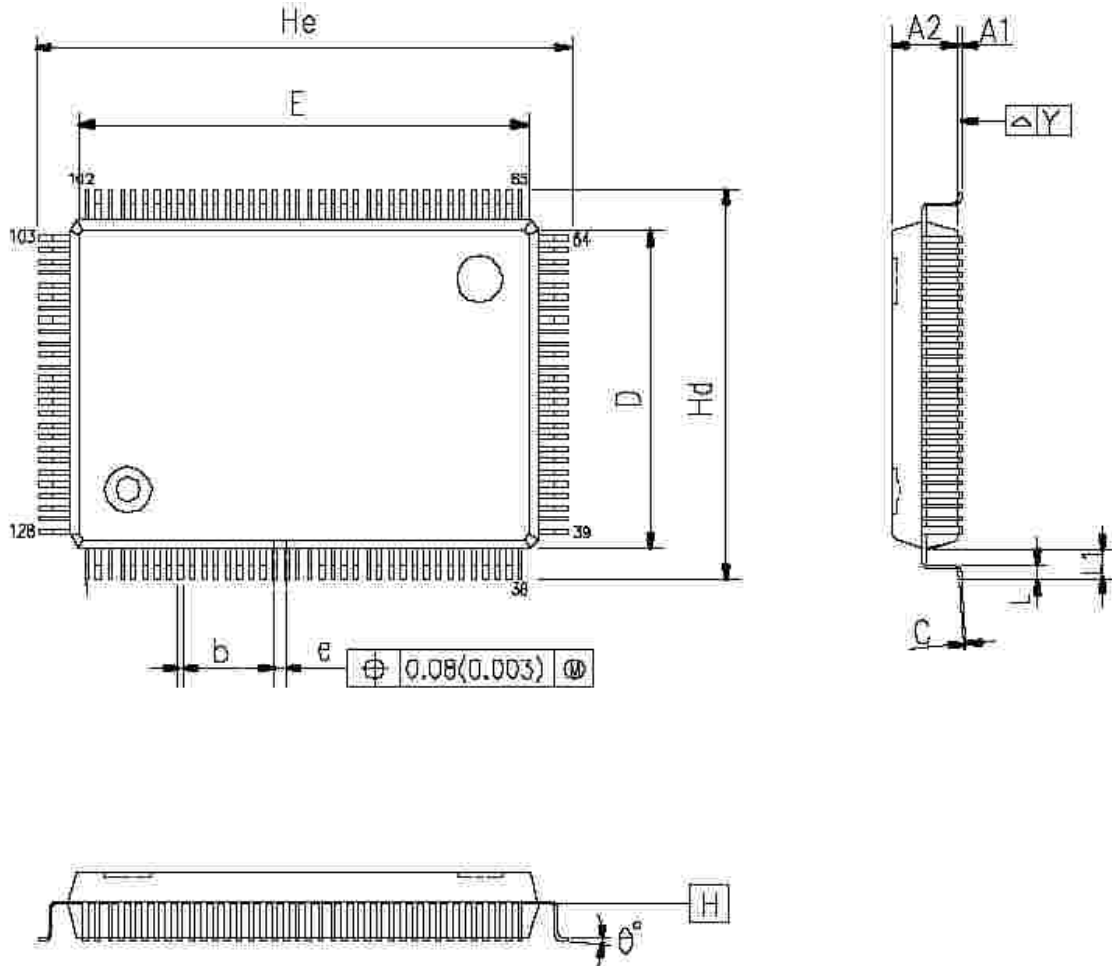

### 8.2 Dimension parameters

SYMBOLS	MIN.	NOM.	MAX.
A1	0.25	0.35	0.45
A2	2.57	2.72	2.87
b	0.10	0.20	0.30
C	0.10	0.15	0.20
D	13.90	14.00	14.10
E	19.90	20.00	20.10
e	—	0.50	—
Hd	17.00	17.20	17.40
H <sub>e</sub>	23.00	23.20	23.40
L	0.65	0.80	0.95
L1	—	1.60	—
Y	—	—	0.08
$\theta^{\circ}$	0	—	12

UNIT : mm

#### NOTES:

1. JEDEC OUTLINE: N/A
2. DATUM PLANE  $H$  IS LOCATED AT THE BOTTOM OF THE MOLD PARTING LINE COINCIDENT WITH WHERE THE LEAD EXITS THE BODY.
3. DIMENSIONS E AND D DO NOT INCLUDE MOLD PROTRUSION. ALLOWABLE PROTRUSION IS 0.25 mm PER SIDE. DIMENSIONS E AND E DO INCLUDE MOLD MISMATCH AND ARE DETERMINED AT DATUM PLANE  $H$ .
4. DIMENSION b DOES NOT INCLUDE DAMBAR PROTRUSION.