



Features

- 2,000 counts LCD display
- LQFP 100L package
- 3V DC power supply
- ADC Conversion rate : 3 times/s
- Full automatic measurement
 - * Voltage measurement : 200.0mV, 2.000V – 1000V
 - * Current measurement : $\mu\text{A}/\text{mA}/\text{A}$
 - * Resistance measurement :
20.00 Ω – 200.0M Ω
 - * Capacitance measurement :
2.000nF – 20.00mF
- (Taiwan patent no.: 323347, 453443)
- * Not contact AC electric field detection
- * Frequency counter : 200.0Hz – 20.00MHz
- AC/DC voltage scan mode (support LoZ)
- Diode measurement & continuity check
- Hazardous AC/DC voltage (HV) indication
(Taiwan patent no.: 536023)
- 4 ADP modes with external reference voltage and independent “ADP” user-defined segment on LCD
- Temperature mode with internal scale translation circuit from $^{\circ}\text{C}$ to $^{\circ}\text{F}$
- K-type thermocouple reference table compensation (-200 ~ 1350 $^{\circ}\text{C}$ range)
- Push function :
 - * AC VAHz function
 - * ACV 3-Phase rotation indication
(Taiwan patent no.: 553319)
 - * MAX/MIN/REL function
 - * Zero function: DCA clampmeter only
 - * Back Light function
 - * KEY function
 - * Data Hold & RS232 output function
 - * Range change function

- Band-gap reference voltage output
- Semi-auto calibration operation
(Taiwan patent no.: 367334)
- Voltage overflow selection (DC / AC : 1010V, DC / AC : 610V)
- LCD segment check when power on
- Auto power off (30min / 15min)
- Sleep state indicative signal output
- Re-power on
- On-chip buzzer driver
- Low battery detection

■ Description

ES252 is an integrated analog-to-digital converter with 2,000-count LCD, automatic range selection, and 3V DC power supply. Automatic range selection is provided for ACV/DCV measurement, resistance measurement, current measurement, capacitance measurement, and frequency counter. Expensive and bulky mechanical range switches are not required. Other features include relative value display, offset removing feature for DCA clamp mode, data holding, maximum and minimum value holding, 3-phase AC voltage phase-rotation detection, diode measurement, temperature measurement, continuity checking, low battery detection, auto power off, re-power on, backlight driver, buzzer driver and RS232 data output.



Application

- Digital multimeter
- Clamp meter

Pin Assignment

- 100L LQFP package

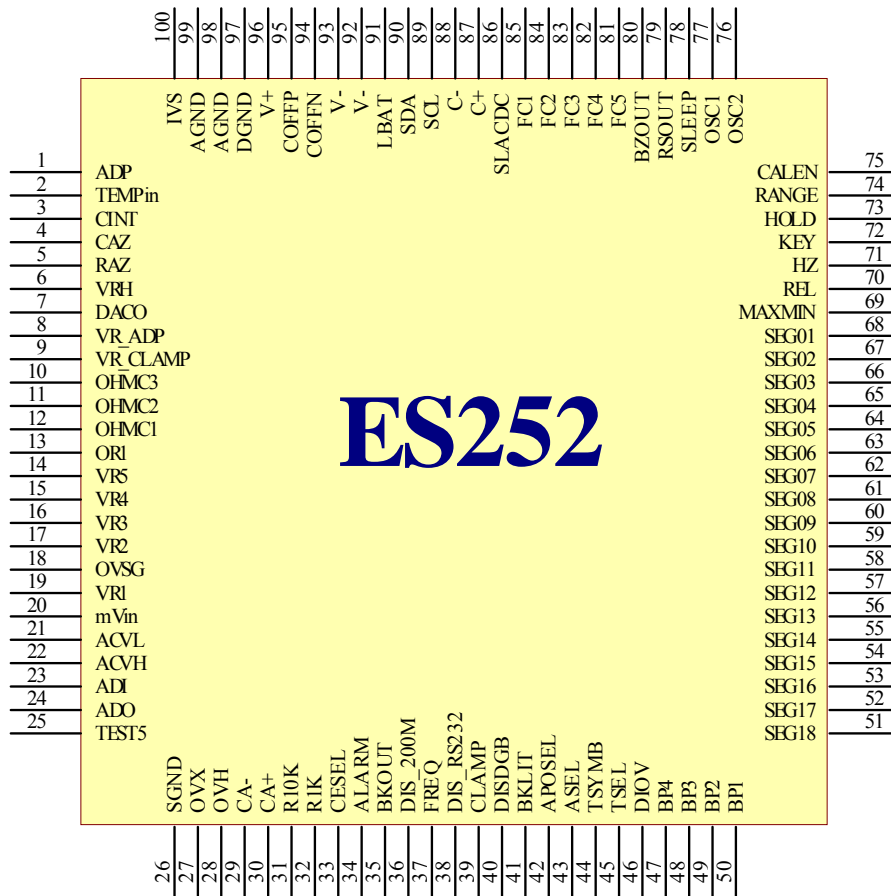



Pin Description

Pin No	Symbol	Type	Description
1	ADP	I	Measurement input in ADP mode.
2	TEMPin	I	Measurement input in Temperature mode.
3	CINT	O	High-resolution integrator output. Connect to integral capacitor. (Metalized Polypropylene Film Capacitor type is recommended)
4	CAZ	O	High-resolution auto-zero capacitor connection.
5	RAZ	O	Buffer output pin in AZ and ZI phase.
6	VRH	O	Output of band-gap voltage reference. Typically $-1.23V$.
7	DACO	O	Output of band-gap voltage reference. Typically -400 mV .
8	VR_ADP	I	Reference input voltage connection. Typically -400 mV .
9	VR_CLAMP	I	Reference input voltage connection. Typically $-400mV$.
10	OHMC3	O	Filter capacitor connection for resistance mode.
11	OHMC2	O	Filter capacitor connection for resistance mode.
12	OHMC1	O	Filter capacitor connection for resistance mode.
13	OR1	O	Reference resistor connection for 20.00/200.0 Ω range
14	VR5	O	Voltage measurement $\div 10000$ attenuator(1000V)
15	VR4	O	Voltage measurement $\div 1000$ attenuator(200.0V)
16	VR3	O	Voltage measurement $\div 100$ attenuator(20.00V)
17	VR2	O	Voltage measurement $\div 10$ attenuator(2.000V)
18	OVSG	O	Sense low voltage for resistance/voltage measurement
19	VR1	I	Measurement Input. Connect to an accurate 10M Ω resistor.
20	mVin	I	Measurement input in 200.0mV mode.
21	ACVL	I	Rectified signal low input in ACV/ACA mode. Connect to negative output of external AC to DC converter.
22	ACVH	I	Rectified signal high input in ACV/ACA mode. Connect to positive output of external AC to DC converter.
23	ADI	I	Negative input of internal AC to DC OP Amp.
24	ADO	O	Output of internal AC to DC OP Amp.
25	TEST5	O	Buffer output of OVSG.
26	SGND	I	Signal Ground input.
27	OVX	I	Sense input for resistance / capacitance measurement.
28	OVH	O	Output connection for resistance measurement.
29	CAN	I / O	Negative auto-zero capacitor connection for capacitor measurement.
30	CAP	I / O	Positive auto-zero capacitor connection for capacitor measurement.
31	R10K	O	Connect to a precised 10K Ω resistor for capacitor measurement.
32	R1K	O	Connect to a precised 1K Ω resistor for capacitor measurement.
33	CESEL	I	Voltage OL selection feature control pin. (1010V/610V)
34	ALARM	O	HV signal detection in Voltage mode and EF mode indication output.
35	BKOUT	O	If BKLIT function is enabled, this pin will change from V- to V+. Once press BKLIT pin again within 300 sec, this pin will change back to V-.
36	DIS_200M	I	Pulled to V- to disable the 200M ohm range at R measurement mode.



Pin Description (Continued)

Pin No	Symbol	Type	Description
37	FREQ	I	Frequency counter input, offset V-/2 internally by the chip.
38	DIS_RS232	I	Assert low (V-) to make serial data output function NOT available. Pulled to V+ to make serial data output ON always
39	CLAMP	I	In μ A or mA modes, it is used to control the ‘ μ ’ or ‘m’ sign. Set to V- to enable clamp current mode and set initial voltage range to 200V.
40	DISDGB	I	Control warning buzzer output at HV mode. Pulled to low is not available.
41	BKLIT	I	Pulled to low to make back light function enabled. Push KEY larger than 2 sec. to enable BKOUT pin.
42	APOSEL	I	Idle time selection for auto power off feature.
43	ASEL	I	Current mode OL indication for 2000A (CLAMP = V-) or 20A (CLAMP = Floating) ranges
44	TSYMB	I	Pulled to V- to disable input terminal symbol displayed on the LCD panel selection pin.
45	TSEL	I	Pulled to V- to enable auto range for TEMP mode.
46	DIOV	I	Pulled to V- to select the open voltage of diode mode to 2.8V.
47	BP4	O	LCD backplane 4.
48	BP3	O	LCD backplane 3.
49	BP2	O	LCD backplane 2.
50	BP1	O	LCD backplane 1.
51 - 68	SEG18 - SEG01	O	LCD segment line 01 – 18.
69	MMX	I	Pulse to V- to enable MAX/MIN function.
70	REL	I	Pulse to V- to enable/disable Relative function or Zero function.
71	HZ	I	Pulse to V- to enable VAHZ mode.
72	KEY	I	Pulse to V- to change mode.
73	HOLD	I	Pulse to V- to enable HOLD function. Pulse to V- larger than one second to enable RS232 output. When RS232 output is enabled, the APO will be disabled automatically.
74	RANGE	I	Pulse to V- to enable manual mode and manual range selection.
75	CALEN	I	Pulled to V- to enable the calibration scheme.
76-77	OSC1-2	-	Connect to 4MHz crystal oscillator
78	SLEEP	O	Sleep mode indicator, asserts low in SLEEP mode.
79	RSOUT	O	Serial data output.
80	BZOUT	O	Outputs a 2KHz audio frequency signal for driving piezoelectric buzzer
81	FC5	I	Switch 5 for function selection.
82	FC4	I	Switch 4 for function selection.
83	FC3	I	Switch 3 for function selection.
84	FC2	I	Switch 2 for function selection.
85	FC1	I	Switch 1 for function selection.



Pin Description (Continued)

Pin No	Symbol	Type	Description
86	SLACDC	I	Select initial DC/AC state.
87	CN	O	Negative capacitor connection for on-chip DC-DC converter.
88	CP	O	Positive capacitor connection for on-chip DC-DC converter.
89	SCLP	O	Output to EEPROM 24LC02 clock.
90	SDAP	I / O	Input / Output from to EEPROM 24LC02 data. Open drain output.
91	LBAT	I	Multi-level low battery configuration input. Simple external resistor divider is required.
92	V-	P	Negative supply voltage.
93	V-	P	Negative supply voltage.
94	COFFN	O	Offset canceled capacitor negative terminal for temperature mode
95	COFFP	O	Offset canceled capacitor positive terminal for temperature mode
96	V+	O	Output of on-chip DC-DC converter.
97	DGND	P / G	Digital ground.
98	AGND	P / G	Analog ground.
99	AGND	P / G	Analog ground.
100	IVS	I	Measurement input in uA/mA current mode.



Absolute Maximum Ratings

Characteristic	Rating
Supply Voltage (V- to AGND)	-4V
Analog Input Voltage	V- -0.6 to V+ +0.6
V+	V+ \geq (AGND/DGND+0.5V)
AGND/DGND	AGND/DGND \geq (V- -0.5V)
Digital Input	V- -0.6 to DGND +0.6
Power Dissipation. Flat Package	500mW
Operating Temperature	-20°C to 70°C
Storage Temperature	-45°C to 125°C

Electrical Characteristics

Ta = 18~28 °C

Parameter	Symbol	Test Condition	Min.	Typ.	Max	Units
Power supply	V-		2.4	-3.0	3.3	V
Operating supply current In DCV mode	I _{DD}	Normal operation	—	1.8	2.5	mA
	I _{SS}	In sleep mode	—	—	10	μA
Voltage roll-over error	REV	10MΩ input resistor	—	—	±0.1	%F.S ¹
Voltage nonlinearity	NLV	Best case straight line CINT=MPR capacitor	—	—	±0.1	%F.S ¹
Zero input reading		10MΩ input resistor (V=-3V)	-000	000	+000	counts
Band-gap reference voltage	V _{REF}	100KΩ resistor between VRH & AGND	-1.30	-1.23	-1.16	V
Open circuit voltage for 200Ω measurement		V=-3V	—	-3.0	—	V
Open circuit voltage for other Ω measurement			-1.19	-1.08	-0.97	V
Peak to peak backplane voltage		-3.3V ≤ V ≤ -2.2V	3.0	3.1	3.2	V
Internal pull-high to 0V current		Between V- pin and HOLD, RANGE, KEY, FC1-FC5, BKLIT,	—	1.2	—	μA
		Between V- pin and DIS_RS232 pin	—	11	—	μA
AC/DC scan mode sensitivity		ACV selected	—	300	—	mVrms
AC frequency response at 2.000V range		±1%	—	40-400	—	HZ
		±5% (No compensated)	—	400-2000	—	
Multi-level low battery detector	V _{t1}	LBAT9 vs. V-	—	2.15	—	V
	V _{t2}		—	1.82	—	
Reference voltage temperature coefficient	TC _{RF}	-20°C < T _A < 70°C	—	100	—	ppm/°C
Capacitance measurement accuracy		2nF-200uF (Residual value is not included)	-1.0	—	1.0	%
			-3	—	3	counts
Capacitance measurement accuracy		2mF/20mF	-3.0	—	3.0	%
			-3	—	3	counts

Note:

1. 2000 counts Full Scale.



Function Description

1. Operating Modes

1.1. Semi-auto calibration scheme

ES252 includes DMM & Clamp-on meter features in single chip. DMM manufacturers need the calibration process in production. The traditional solution needs the variable resistors for calibration by manual adjustment. ES252 provide another calibration scheme and the most variable resistors could be ignored. When ES252 is at OFF-state, pull *CALEN* (pin 75) to V- to active the calibration scheme after re-power on. A digital controlled voltage output will be active from DACO. When semi-auto calibration scheme is active, use **HOLD** (or **REL**) key to decrease voltage and use **RANGE** (or **MMX**) key to increase the voltage. Decrease the reference voltage means the counts on display will be increased. Increase the reference voltage means the counts on display will be decreased. The adjustment step is approximate one count. If coarse adjustment is required, push **HOLD** (or **REL**) and **RANGE** (or **MMX**) larger than one second to speed up to approximate 10 counts per second. After calibration process is finished, push **HOLD** (or **REL**) and **RANGE** (or **MMX**) simultaneously less than 1 second to save the digital controlled code to external EEPROM (24LC02).

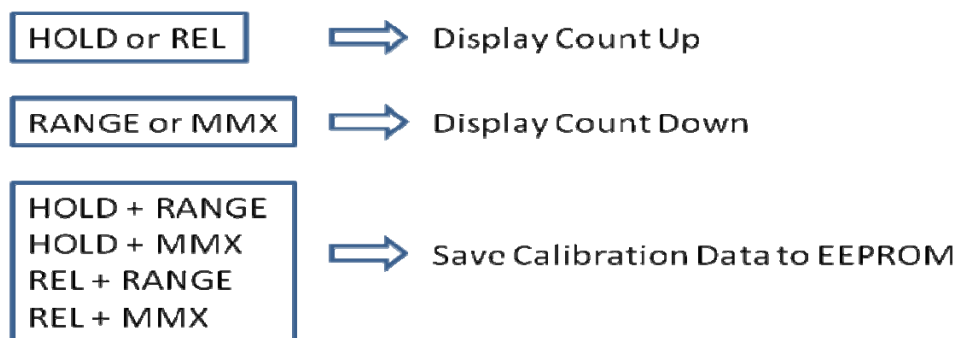

The semi-auto calibration scheme supports the following eleven measurement modes. When *CALEN* pin is active, set the proper function switches or push KEY to choose the target measurement mode. When mode is selected, the LCD segment of Unit at related measurement will be blinking.



Mode	Default Range For CAL	Remark
Voltage Measurement	2.000V (DC/AC separated)	Accuracy of other ranges is guaranteed by external resistor network.
mV Voltage Measurement	200.0mV (DC/AC separated)	
DC Current Measurement For Multi-meter (uA/mA)	N/A	The same configuration for DCV mode.
AC Current Measurement For Multi-meter (uA/mA)	AC 200.0uA / AC 20.00mA	Select lower range for calibration in AC mode. Higher range calibration use the same as ACV mode.
DC Current Measurement For Multi-meter (A)	2A or 20A	Auto 2 ranges choose one, proposed to use a large range to calibration.
AC Current Measurement For Multi-meter (A)	2A or 20A	Auto 2 ranges individual for calibration is necessary.
DC Current Measurement for (Clamp-meter application)	20A or 200A (one of both modes chosen for calibration)	Auto 2 ranges choose one, proposed to use a large range to calibration.
AC Current Measurement for higher range (Clamp-meter)	999.9A or 2000A (one of both modes chosen for calibration)	Auto 2 ranges separated for calibration is necessary.
AC Current Measurement for lower range (Clamp-meter)	20.00A or 200.0A (one of both modes chosen for calibration)	
Current measurement for Clamp-meter application	2A/20A/200A/2000A (DC/AC separated)	Manual 4 ranges separated for calibration is necessary
Capacitor Measurement	20.00nF/20.00uF	2 ranges separated for calibration
Temperature Measurement	200.0°C	Lower range in auto temperature measurement.
ADP Measurement	2000 / 200.0 / 20.00 / 2.000	4 ranges separated for calibration.

After calibration procedure is finished, set ES252 to OFF-state and set *CALEN* (pin75) to DGND or kept floating to return to normal mode operation after re-power on.



1.2. Voltage Measurement

A re-configurable voltage divider automatically provides a suitable range in voltage measurement mode. 200.0mV range is independent and manual mode. It takes input signal from *mVin* (pin20). The following table summarizes the Full-Scale ranges in each configuration.

Configuration	Full Scale Range	Divider Ratio	Resister Connection	Input Pin	CAL
VR1	200.0mV	1	-	<i>mVin</i> V.S. <i>SGND</i>	Yes
VR2	2.000V	1/10	VR2 (1.111MΩ)	<i>VR1</i> V.S. <i>SGND</i>	Yes
VR3	20.00V	1/100	VR3 (101KΩ)	<i>VR1</i> V.S. <i>SGND</i>	N/A
VR4	200.0V	1/1000	VR4 (10.01KΩ)	<i>VR1</i> V.S. <i>SGND</i>	N/A
VR5	1000V	1/10000	VR5 (1KΩ)	<i>VR1</i> V.S. <i>SGND</i>	N/A

Note: The *CLAMP* pin is used to control the voltage start range from 2.000V or 200.0V. Set to V- to select the initial range at 200.0V and set to floating state to select the initial range at 2.000V.

The ES252 support the hazardous live voltage warning. When the voltage measured exceeds the level defined, the buzzer generates 2KHz beep and *ALARM* (pin 34) drive high output (V+ level) periodically. It can remind the user to notice the hazardous voltage. The buzzer sound warning could be cancelled by *DISDGB* (pin40).

1.2.1. OL Selection

ES252 has a voltage OL selection feature archived by configuring the pin *CESEL* (pin33). In automatic voltage mode, ES252 will show OL when the voltage exceeds the defaulted level. If *CESEL* is connected to V-, ES252 will have a 1010V overflow level in voltage mode. If *CESEL* connected to DGND, the overflow level will be set to 610V in DCV and ACV mode. The configuration of *CESEL* is listed below. When *CESEL* is kept floating, ACV OL level is set to 760V.

For ACV/DCV voltage modes:

	<i>CESEL</i>		
	V-	DGND	Floating
DCV	1010V	610V	1010V
ACV	1010V	610V	760V



1.3. Current Measurement For Multi-meter

ES252 has 3 automatic current measurement modes for multi-meter. The following table summarizes the full-scale range of each mode. When ES252 operates in the current measurement modes for multi-meter, it takes high input from pin *IVS*, low input from pin *SGND* and reference voltage from calibration scheme.

Mode	FC1~4	Full Scale	Input Terminal	CAL
Automatic1	1,1,0,1	200.0μA / 2000μA	IVS V.S. SGND	AC 200μA ³
Automatic2	1,1,1,1	20.00mA / 200.0mA	IVS V.S. SGND	AC 20mA ³
Automatic3	0,0,0,0	2.000A / 20.00A ²	IVS V.S. SGND	Yes

Note:

1. Connect *Clamp* (pin39) to V- will disable the “μ₂” / ”m₂” symbol on LCD panel.
2. Connect *ASEL* (pin43) to V- will set maximum readings of input for Automatic3 mode to 10.00A.
3. DCuA/DCmA use the same configuration as DCV mode. AC higher range use the same configuration as ACV mode.

1.4. Current Measurement For Clamp-meter

ES252 has 2 automatic and 4 manual current measurement modes for Clampmeter. The following table summarizes the Full-Scale range of each mode. When ES252 operate in the automatic modes and the manual mode1~4, it takes high input from *IVS* pin, low input from *SGND* and reference voltage from *VR_CLAMP*.

Mode	FC1~4	¹ CLAMP	Range	Max full scale	Input Terminal	CAL
Automatic1	1,1,0,1	0	200.0A / 2000A ²	20/200 mV	IVS V.S. SGND	Yes ⁴
Automatic2	1,1,1,1	0	20.00A / 999.9A	20/1000 mV	IVS V.S. SGND	Yes ⁴
Automatic3	0,0,0,0	0	2.000A / 20.00A	20/200 mV	IVS V.S. SGND	Yes ⁴
Manual1	1,1,0,0	X	2.000A	200 mV	IVS V.S. SGND	Yes
Manual2	1,0,0,0	X	20.00A	200 mV	IVS V.S. SGND	Yes
Manual3	1,0,1,0	X	200.0A	200 mV	IVS V.S. SGND	Yes
Manual4	1,0,0,1	X	1000A or 2000A ²	100 or 200 mV	IVS V.S. SGND	Yes

Note:

1. Connect *CLAMP* to V- will disable the “μ₂” / ”m₂” symbol on LCD panel.
2. Connect *ASEL* to V- will set maximum of input for Automatic1 & Manual4 modes to 1000A.
3. In DC current modes for clamp-meter, ES252 provides **Zero Function (pin70)** for offset removing.
4. AC Lower range calibration use the same configuration as Manual3 ACA mode. AC Higher range calibration use the same configuration as Manual4 ACA mode.



1.5. Resistance Measurement

A re-configurable divider automatically provides a suitable Full-Scale range in resistance measurement mode.

The following table summarizes the full-scale ranges and the reference resistors in each configuration.

Configuration	Full Scale Range	Relative Resistor	Equivalent value
OR0	20.00Ω	OR1	100Ω
OR1	200.0Ω	OR1	100Ω
OR2	2.000KΩ	VR5	1KΩ
OR3	20.00KΩ	VR4 VR1	10KΩ
OR4	200.0KΩ	VR3 VR1	100KΩ
OR5	2.000MΩ	VR2 VR1	1MΩ
OR6	20.00MΩ	VR1	10MΩ
OR7*	200.0MΩ	VR1	10MΩ

Note: If pin36 (DIS_200M) is pulled to V-, the 200MΩ range will be disabled.

1.6. Capacitance Measurement

The following table summarizes the eight ranges of capacitance measurement mode.

Configuration ¹	Full Scale Range	Relative Resistor	Measurement Period
C1³	2.000nF	Ratio to C2	0.33 sec
C2²	20.00nF	CAL	0.33 sec
C3	200.0nF	Ratio to C2	1.15 sec
C4	2.000uF	Ratio to C2	1.15 sec
C5	20.00uF	CAL	0.26 sec
C6	200.0uF	Ratio to C5	2.6 sec(max)
C7	2.000mF	Internal matching	2.6 sec(max)
C8	20.00mF	Internal matching	26 sec(max)

Note:

1. In order to obtain an accurate reading, a capacitor must be discharged before measurement begins. The chip has a built-in discharge mode to automatically discharge the capacitor. In discharge mode, the main-display shows **dIS.C**. Discharging through the chip is quite slow. We recommend users to discharge the capacitor with some other apparatus.
2. The C2 range is calibrated in calibration scheme.
3. The C1 range residual offset could be compensated by the small capacitors near to OVH pin.



1.7. Continuity Check

Continuity check shares the same configuration with 200.0Ω manual resistance measurement mode and has buzzer output to indicate continuity. The buzzer generates 2KHz beep and *ALARM* (pin 34) drive high output (V+ level) whenever the reading is less than 30Ω. The ES252 built in a high-speed short detection circuit and the detection could be less than 10ms.

1.8. Diode Measurement

Diode measurement mode shares the same configuration with 2.000V manual voltage measurement mode and has buzzer output to indicate continuity. When the good diode is measured, a single beep will be generated. The buzzer generates a 2KHz sound and *ALARM* (pin 34) drive high output (V+ level) whenever the reading is less than 30mV. If the test circuit is open or the voltage drop between the two ports of the diode under test is larger than 2V or 2.8V (depends on *DIOV* pin level), the LCD panel will show “OL”.

	<i>DIOV</i>	
	DGND/Floating	V-
OL	2.000V	2.80V

The ES252 also support a LED forward voltage measurement mode. It is necessary to use external source to achieve the measurement. The following table & diagram summarizes the diode & LED measurement mode.

Mode	SLACDC	FC1~5	Full Scale	Input Terminal
LED	1	0,1,1,0,0	3.50V	VRI V.S. SGND

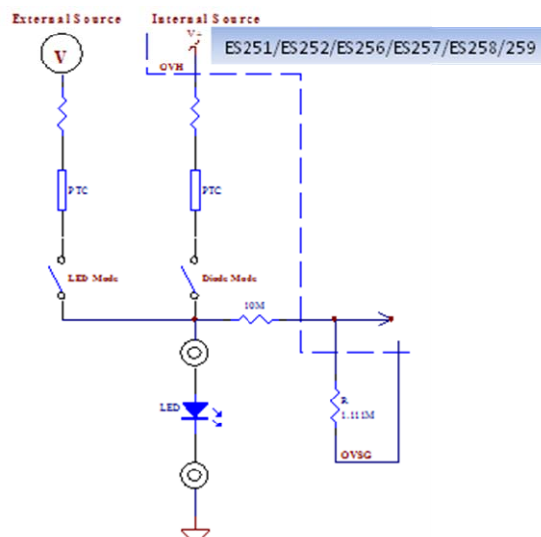



1.9. Frequency Counter

The time base of the frequency counter is derived from an external crystal oscillator by

$$T_{\text{counter}} = \frac{4,000,000}{F_{\text{osc}}}$$

Where F_{osc} is the frequency of the crystal oscillator. Thus, the counter has a 1-second time base when a 4MHz oscillator is used. The frequency counter can select the proper range automatically or manually. Auto-range operation extends over six decades, from 200.0Hz to 20.00MHz. The following table summarizes the Full-Scale range of the frequency counter.

Range	Full Scale
FR1	200.0Hz
FR2	2.000KHz
FR3	20.00KHz
FR4	200.0KHz
FR5	2.000MHz
FR6	20.00MHz

*If input frequency is less than 1.0Hz, ES252 will show **0.0Hz**

1.10. Electrical field detection mode

ES252 supports a non-contact AC voltage measurement, which is called electric field measurement also. The ADC input is configured from *ADP* pin vs. *SGND*. When no or less electric field is detected, the LCD display shows “EF”. If the electric field is detected, the strength will be showed on the LCD display by “-“ not digits type. Level 1 (equivalent to 12.5% full scale of ADC) is “-“ and the level 4 (equivalent to 100% full scale of ADC) is “----“. Additional beeper (*BUZOUT* pin) and LED alarm (*ALARM* pin) will be active from ES252. The frequency of buzzer and LED alarm depends on the strength of electric field also. The faster beeper means the stronger electric field (AC voltage) is sensed.

Mode	FC1~4	SLACDC	Input Terminal
EF	1,1,1,0	1	ADP V.S. SGND

EF test circuit

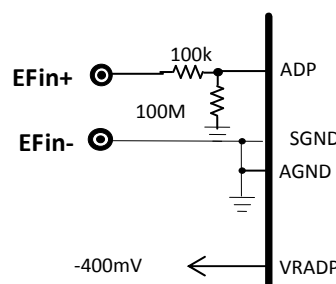



1.11. Temperature Measurement mode

Temperature measurement mode takes input signal from *TEMPin* (pin2). The ES252 has °C to °F scale translation circuit and standard K-type thermocouple reference table is built-in. External cold-junction compensation circuit is still necessary. In temperature measurement mode, there is automatic mode and manual mode. The *TSEL* pin (pin45) is used to control the automatic mode (0.1°C/1°C resolution) or manual mode (0.1°C resolution) selection. *TSYMB* (pin 44) could enable or disable display of input terminal symbol on the LCD panel (SEG18).

	Manual range	Auto Range
°C range	-200.0 °C ~ 200.0 °C	-200.0 °C ~ 200.0 °C / 1350 °C
°F range	-328.0 °F ~ 392.0 °F	-328.0 °F ~ 392.0 °F / 2462 °F

1.12. ADP

ES252 provides 4 manual range ADP measurement modes for user define. The *ADP* pin is auxiliary input terminal for ADC of ES252. The full scale for ADP mode is 200.0mV. If FC5=0, the minus sign will not be shown on LCD segment.

Mode	FC1~4	SLACDC	Full Scale	Input Terminal	CAL
ADP0	0,0,1,1	1	2000	ADP V.S. SGND	Yes
ADP1	0,0,0,1	1	200.0	ADP V.S. SGND	Yes
ADP2	0,1,1,1	1	20.00	ADP V.S. SGND	Yes
ADP3	0,0,1,0	1	2.000	ADP V.S. SGND	Yes

Note: If FC5 is set to V-, the minus sign will be disabled.



1.13. Auto Power Off And Idle Time Selection

ES252 has a default auto power off function. If the meter is idle for more than the given idle time duration, the chip automatically turns the power off. The idle time to trigger the auto power off function is determined by *APOSEL* (pin 42). If *APOSEL* is connected to V-, the idle time will be set to 30 minutes. If pin *APOSEL* is floating, the idle Time will be set to 15 minutes. When APO is occurred, the state of the meter is reserved. The APO symbol on the LCD panel indicates whether the auto power off is enabled or not. In some cases, user might want to disable Auto power off. There are two ways to disable this feature as following:

1. Power on the meter when any of the push functions, except for **HOLD**, is pressed down.
2. In addition, when RS232 output is active, the auto power off function is also disabled automatically.

Note: Powering on the meter while pressing HOLD and lasts 2 seconds turns on all LCD segments until HOLD is pressed again.

1.14. Sleep

The meter enters sleep mode after auto power off. The *SLEEP* (pin 78) asserts low (V-) in the sleep mode, and asserts high (V+, not 0V) after re-power on.

1.15. Re-Power On

After auto power-off, pushing any of the push function or changing the rotary mode can turn on the meter again. If the meter is re-powered on by changing the rotary mode, the saved state is cleared. If the meter is re-powered on by push functions, the chip restores the saved state and enters HOLD mode. The LCD displays the saved value.



1.16. Hazardous Voltage Indication

The ES252 could provide the AC/DC hazardous voltage indication for voltage/resistor/capacitor/diode/frequency modes. Of course, the indication could support LCD symbol /LED /Buzzer driving simultaneously. Especially ES252 could detect the AC voltage in DCV mode and detects the DC voltage in ACV mode. It means if not proper AC or DC voltage signal exists on the DUT when DCV or ACV measurement mode is set, the HV indication will be active.

HV indication criterion

Function / Range	Input DC voltage (typ.)	Input AC voltage (typ.)
AC mV	> $\pm 3V$	OL
AC 2V	> $\pm 20V$	OL
AC 20V – 1000V	> $\pm 100V$	> 30V
DC mV	OL	> 3Vrms (40-1kHz)
DC 2V	OL	> 20Vrms (40-1kHz)
DC 20V-1000V	> 30V or < -30V	> 90Vrms (40-1kHz)
Frequency modes	> 70V or < -70V	> 40Vrms (40-1kHz)
Res/Cap/Diode modes	> 10V or < -10V	> 10Vrms (40-1kHz)

Note: If AC+DC signal is applied, the voltage criterion will be changed.



1.17. Multi-level Low Battery Voltage Detection

ES252 provides a voltage detection input (pin 91: *LBAT*) for multi-level low battery application. There are two internal voltage reference V_{t1} & V_{t2} for comparing with *LBAT*. If *LBAT* is larger than V_{t1} , the LCD segment of SLB1 – SLB3 will active always. This status implies Full battery. When *LBAT* is less than V_{t1} but larger than V_{t2} , the LCD segment of SLB1 will disappear and this status implies Half battery. When *LBAT* is less than V_{t2} , the LCD segment of SLB2 will disappear and this status implies low battery. When the Low battery status lasts for 10 seconds, the LCD segment of SLB3 will be blinking. When the SLB3 is blinking for ~20 seconds, the operation of meter will be inhibited and LCD panel will show “Lo.bt” symbol. In this case, it is suggested to replace a new battery immediately. After “Lo.bt” appears and lasts for around 80 seconds, ES252 will enter to auto power off mode instantly.

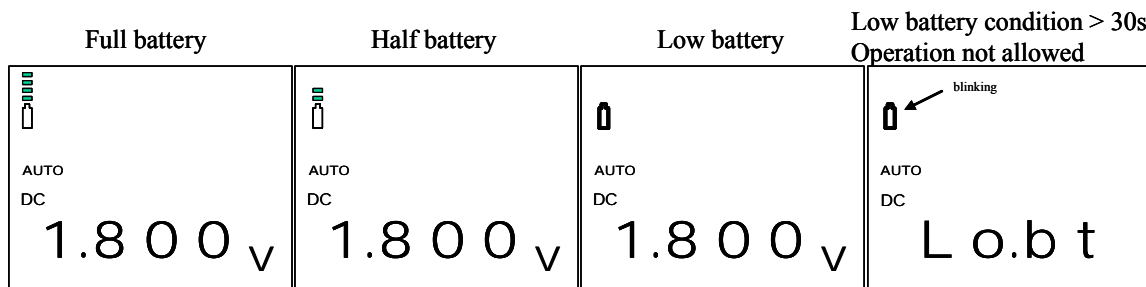

Low battery test circuit (a)

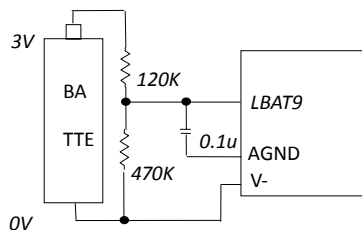

Low battery test circuit (b)

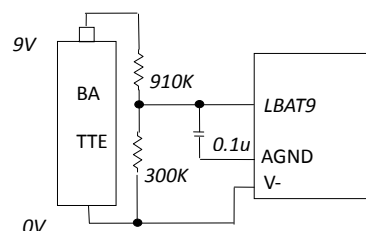



2.Measurement Mode Switching

Measurement mode depends on the logic level of *SLACDC*, *FC1*, *FC2*, *FC3*, *FC4*, *FC5* and **KEY** selection. When *FC5* is high, the measurement mode list is shown below:

<i>SLACDC</i>	<i>FC1</i>	<i>FC2</i>	<i>FC3</i>	<i>FC4</i>	Mode	KEY selection
0	1	0	1	1	DC Voltage Measurement	DCV ↔ ACV
0	1	1	0	1	²³ Auto DC Current Measurement(μA)	DCA ↔ ACA
0	1	1	1	1	²³ Auto DC Current Measurement(mA)	DCA ↔ ACA
0	0	0	0	0	²³ Auto DC Current Measurement(A)	DCA ↔ ACA
0	1	1	1	0	Resistance Measurement	Ω → Continuity → Diode → Cap
0	1	1	0	0	³ Manual DC 2.000A	DCA ↔ ACA
0	1	0	0	0	³ Manual DC 20.00A	DCA ↔ ACA
0	1	0	1	0	³ Manual DC 200.0A	DCA ↔ ACA
0	1	0	0	1	³ Manual DC 2000A	DCA ↔ ACA
0	0	0	1	1	Resistance Measurement	Ω ↔ Continuity
0	0	0	0	1	Continuity Check	Continuity ↔ Diode
0	0	1	1	1	Resistance Measurement	Ω → Continuity → Diode
0	0	0	1	0	Frequency Measurement	----
0	0	1	1	0	Capacitance Measurement	----
0	0	1	0	0	Auto Temperature Measurement	°C ↔ °F
0	0	1	0	1	DCmV	DCmV ↔ ACmV
1	1	0	1	1	AC Voltage Measurement	ACV ↔ DCV
1	1	1	0	1	²³ Auto AC Current Measurement(μA)	ACA ↔ DCA
1	1	1	1	1	²³ Auto AC Current Measurement(mA)	ACA ↔ DCA
1	0	0	0	0	²³ Auto AC Current Measurement(A)	ACA ↔ DCA
1	1	1	1	0	EF mode	----
1	1	1	0	0	³ Manual AC 2.000A	ACA ↔ DCA
1	1	0	0	0	³ Manual AC 20.00A	ACA ↔ DCA
1	1	0	1	0	³ Manual AC 200.0A	ACA ↔ DCA
1	1	0	0	1	³ Manual AC 2000A	ACA ↔ DCA
1	0	0	1	1	¹ ADP0 (2000)	----
1	0	0	0	1	¹ ADP1 (200.0)	----
1	0	1	1	1	¹ ADP2 (20.00)	----
1	0	0	1	0	¹ ADP3 (2.000)	----
1	0	1	1	0	Scan ACV/DCV	SCAN → DCV → ACV → SCAN
1	0	1	0	0	Auto Temperature Measurement	°F ↔ °C
1	0	1	0	1	ACmV	ACmV ↔ DCmV

Note:

1. When *FC5* is high, the ADP0, ADP1, ADP2 and ADP3 modes can display minus sign.
2. These modes could be designed for multimeter current modes, please refer to section 1.3.
3. These modes could be designed for clampmeter current modes, please refer to section 1.4.



Measurement Mode Switching (Continued)

Measurement mode depends on the logic level of *SLACDC*, *FC1*, *FC2*, *FC3*, *FC4*, *FC5* and **KEY** selection. When *FC5* is low, the **KEY** function is disabled in most modes. The measurement mode list is shown below:

<i>SLACDC</i>	<i>FC1</i>	<i>FC2</i>	<i>FC3</i>	<i>FC4</i>	Mode	KEY selection & Remaks
0	1	0	1	1	DC Voltage Measurement	----
0	1	1	0	1	²³ Auto DC Current Measurement(μ A)	----
0	1	1	1	1	²³ Auto DC Current Measurement(mA)	----
0	0	0	0	0	²³ Auto DC Current Measurement(A)	----
0	1	1	1	0	Diode Measurement	----
0	1	1	0	0	³ Manual DC 2.000A	----
0	1	0	0	0	³ Manual DC 20.00A	----
0	1	0	1	0	³ Manual DC 200.0A	----
0	1	0	0	1	³ Manual DC 2000A	----
0	0	0	1	1	Resistance Measurement	----
0	0	0	0	1	Continuity Check	----
0	0	1	1	1	Resistance Measurement	----
0	0	0	1	0	Frequency Measurement	----
0	0	1	1	0	Capacitance Measurement	----
0	0	1	0	0	Auto Temperature Measurement	°C
0	0	1	0	1	DCmV	----
1	1	0	1	1	AC Voltage Measurement	----
1	1	1	0	1	²³ Auto AC Current Measurement(μ A)	----
1	1	1	1	1	²³ Auto AC Current Measurement(mA)	----
1	0	0	0	0	²³ Auto AC Current Measurement(A)	----
1	1	1	1	0	EF mode	----
1	1	1	0	0	³ Manual AC 2.000A	----
1	1	0	0	0	³ Manual AC 20.00A	----
1	1	0	1	0	³ Manual AC 200.0A	----
1	1	0	0	1	³ Manual AC 2000A	----
1	0	0	1	1	¹ ADP0 (2000)	----
1	0	0	0	1	¹ ADP1 (200.0)	----
1	0	1	1	1	¹ ADP2 (20.00)	----
1	0	0	1	0	¹ ADP3 (2.000)	----
1	0	1	1	0	LED	----
1	0	1	0	0	Auto Temperature Measurement	°F
1	0	1	0	1	ACmV	----

Note:

1. When *FC5* is low, the ADP0, ADP1, ADP2 and ADP3 modes can't display minus sign.
2. These modes could be designed for multi-meter current modes, please refer to section 1.3.
3. These modes could be designed for clamp-meter current modes, please refer to section 1.4.



3.Push Function

All the enabled push functions will be reset when the measurement mode is changed when FC1-FC5 modes are changed. The following table lists the available function versus every measurement mode.

	HZ	MMX	REL	KEY/BKLIT ⁵	HOLD/RS232 ⁶	RANGE
Voltage mode	AC ⁷	O	O	O	O	O
mV mode	AC	O	O	O	O	X
¹ Current Mode for Multimeter	AC	O	O	O	O	O
² Current Mode for Clampmeter	AC	O	O ³	O	O	O ⁴
Resistance	X	O	O	O	O	O
Continuity	X	O	O	O	O	X
Diode mode	X	O	O	O	O	X
Frequency	X	X	X	O	O	O
Capacitance	X	O	O	O	O	O
Temperature	X	O	O	O	O	O ⁴
EF Mode	X	X	X	O	O	X
ADP mode	X	O	O	O	O	X

Note:

¹Include automatic μ A, automatic mA and manual A modes, please refer to **section 1.3**.

²Include 2 automatic modes and 4 manual modes, please refer to **section 1.4**.

³When clamp-meter DCA mode is selected, the REL function will be changed to ZERO function operation automatically.

⁴Only auto range mode is available.

⁵When *BKLIT* (pin41) is pulled to V-, push KEY and last for 2 seconds will active the back light output driver (BKOUT).

⁶When *DIS_RS232* (pin38) is kept floating, push HOLD key and last for 2 seconds will active RS232 output mode (RSOUT).

⁷When ACV measurement mode is in operation to push Hz key for 2 seconds will active 3-phase rotation detection.



3.1. Range

Push **RANGE**¹ key to switch from automatic to manual mode, and while in manual mode, changes the full-scale range. The following figure shows the state transition.

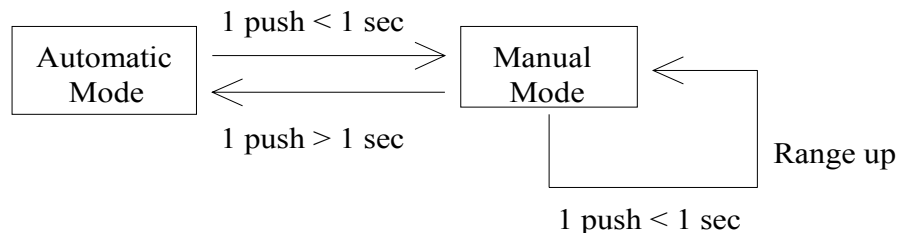

Measurement Mode	Auto	Manual	Control Range	Initial Range
V	VR2 – VR5	VR _i → VR _i + 1, VR ₅ → VR ₂	2.000V – 1000V	2.000V ²
Auto μA	R1 – R2	R1 → R2, R2 → R1	200.0μA – 2000μA	200.0μA
Auto mA	R1 – R2	R1 → R2 R2 → R1	20.00mA – 200.0mA	20.00mA
Auto A	R1 – R2	R1 → R2 R2 → R1	2.000A – 20.00A	2.000A
Auto 20A/1000A (clamp)	R1 – R2	R1 → R2 R2 → R1	20.00A – 999.9A	20.00A
Auto 200A/2000A (clamp)	R1 – R2	R1 → R2 R2 → R1	200.0A – 2000A	200.0A
Capacitance	C1 – C8	C _i → C _i + 1, C ₈ → C ₁	2.000nF– 20.00mF	2.000nF
Capacitance (Clamp)	C1 – C8	C _i → C _i + 1, C ₈ → C ₁	2.000nF– 20.00mF	2.000nF
Ω	OR0 – OR7	OR _i → OR _i + 1, OR ₇ → OR ₀	20.00Ω – 200.0MΩ	20.00Ω
Temp	T1-T2	T1→T2 T2→T1	200.0°C~1350°C	200.0°C
Frequency	FR1 – FR6	FR _i → FR _i + 1 FR ₆ → FR ₁	200.0Hz – 20.00MHz	200.0Hz

Note:

1. Pushing **RANGE** resets all existing special modes except for VAHZ mode.
2. Initial range of voltage mode depends on *Clamp* pin configuration. Pulled to V- to set to 200.0V as initial range.



3.2. HOLD and RS232 output Feature

HOLD mode makes the meter stop updating the LCD panel. This mode can be nested in most of the special modes. Enabling HOLD function in automatic mode makes the meter switch to manual mode, but the Full-Scale range remains the same. ES252 provides a RS232 output feature. To activate RS232 output feature, press down the **HOLD** key and last for 2 seconds. The meter will enable UART port output from RSOUT. (Please see section 4.)

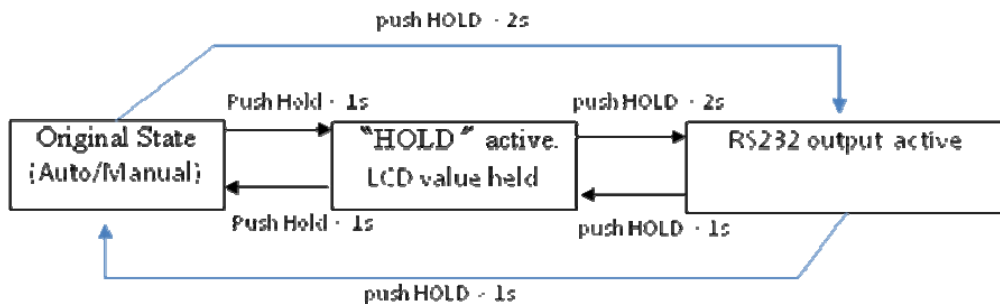

3.3. KEY

See Section “Measurement Mode Switching” for the function of this pin.

3.4. REL + HOLD

In REL mode, the LCD panel displays $D_{N+K} - D_N$, where $N = 1, 2, 3, \dots$, D_N is the last value before **REL** key is pushed, and D_{N+K} is the current value. The meter returns to normal operation if **REL** is pressed again. Pressing **HOLD** in REL mode makes the meter stop updating the LCD panel.

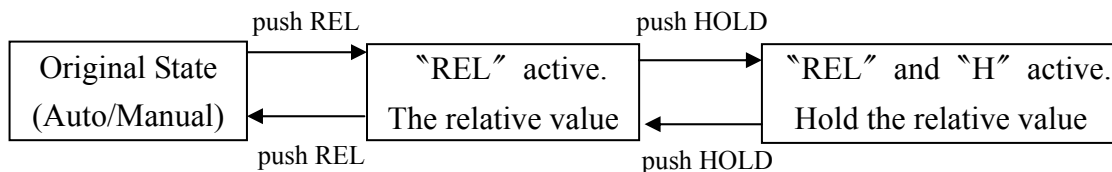

Note:

1. It's possible that relative value ($D_{N+K} - D_N$) exceeds 2,000 or -2,000 counts. The LCD shows OL in REL mode only if D_N or D_{N+K} is more than 2,000 counts.



3.5. Max/Min + HOLD

The meter displays the maximum or minimum value of the input in Max/Min mode. When **MMX** key is pressed for the first time, the meter displays the maximum value. The meter displays the minimum value, when it is pressed again. When **MMX** key is pressed for the third time, the meter displays current value. The meter returns to normal operation if **MMX** is pressed and held for longer than one second. Pressing **HOLD** in Max/Min mode makes the meter stop updating the maximum or the minimum value.

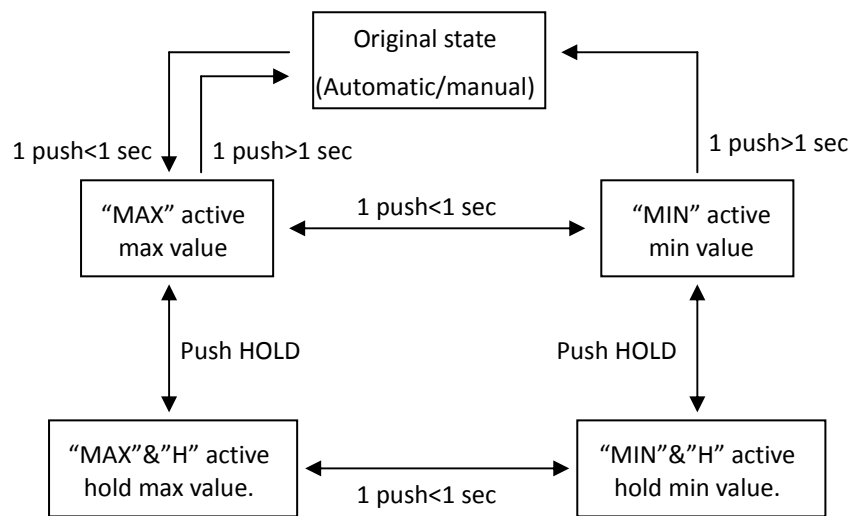



3.6. ZERO Function

In manual DC 2.000A, 20.00A, 200.0A and 2000A, auto DC 20.00A/200.0A, and auto DC 999.9A/2000A (please refer to **section 1.4**) measurement modes, ES252 provides ZERO function to remove the residual current value. Push **REL** key less than one second to enter ZERO mode. In ZERO mode, the LCD panel displays $D_{N+K} - D_N$, where $N = 1, 2, 3, \dots$, D_N is the last conversion value before **REL** key is pushed, and D_{N+K} is the current conversion value. If **REL** key is pushed again in ZERO mode, the meter will refresh the D_N value and displays the $D_{N+K} - D_N$ again. The meter returns to normal operation if **REL** key is pressed and held for longer than one second. Pressing **HOLD** in ZERO mode makes the meter stop updating the LCD panel. In 2-range auto DCA modes for clampmeter (200.0A/2000A or 20.00A/999.9A), the system will stay in automatic mode, even if the ZERO function is activated. In other words, It could achieve real automatic operation. In automatic mode, ZERO function could not be entered from higher range, but it could be still activated if current range is lower one. This is because most residual current value is so small that the range could not be higher one in automatic mode. When enter ZERO mode from lower range, the system will store the nonzero counts (residual current value). If the range goes up to higher one automatically, the nonzero counts will be divided by ten. So this function will still work well in automatic modes.

- State diagram for ZERO mode :

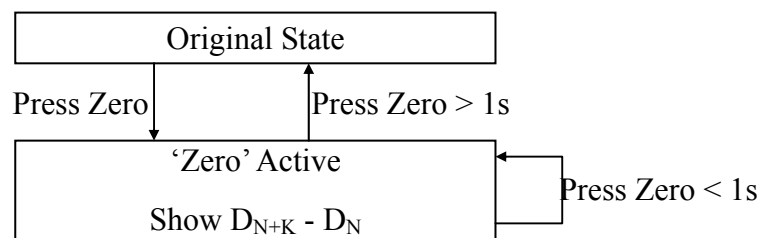

- State diagram for ZERO + HOLD mode :

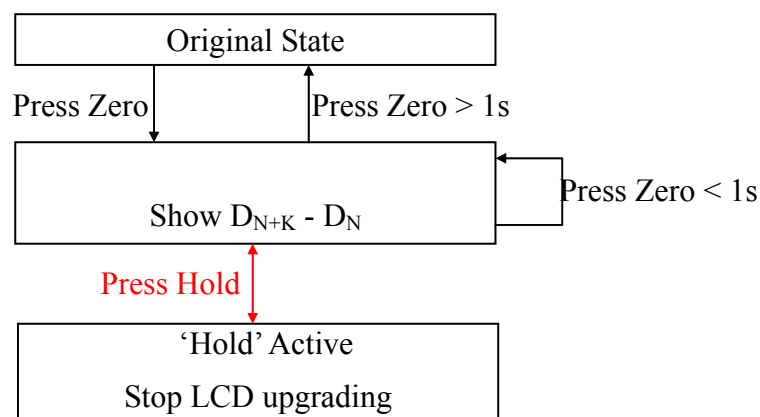



- State diagram for ZERO + Max/Min + HOLD mode :

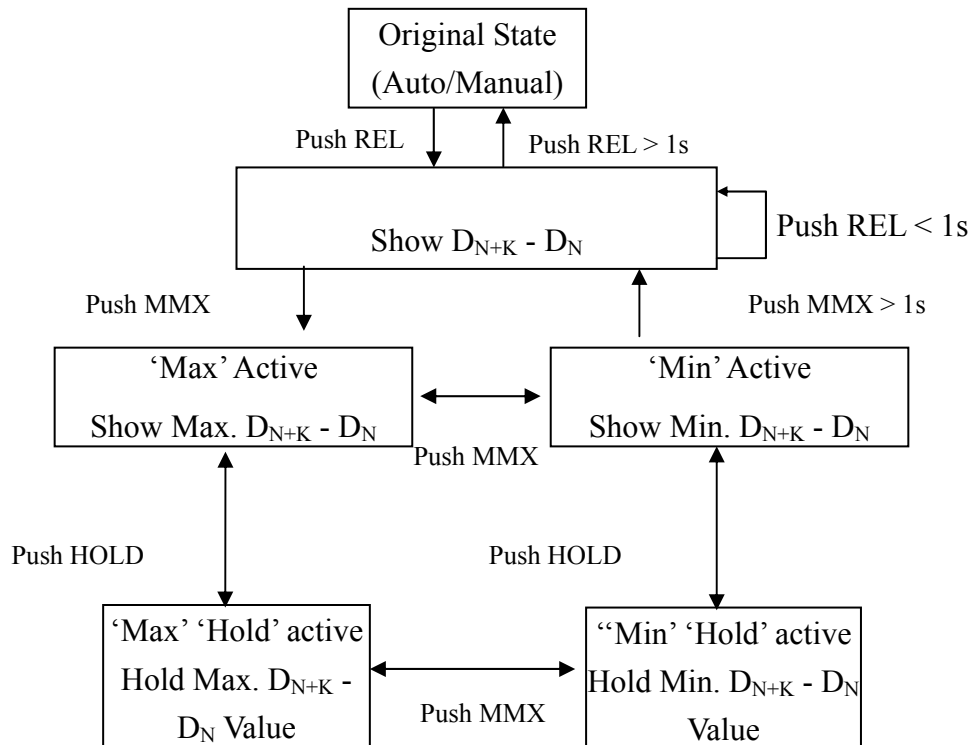

3.7. VAHZ Function

When voltage or current (V/A) measurement mode is selected, the VAHz function is available. Push **HZ** key less than one second to select this frequency measurement mode at V/A modes. The frequency is measured by auto ranging. The maximum frequency range is 99.99KHz. The sensitivity of signal input is 5% full scale of signal in voltage or current mode typically.

Configuration	RANGE
FR1	200.0Hz
FR2	2.000KHz
FR3	99.99KHz



3.8. Phase-rotation detection

The ES252 provide the phase rotation to find the phase sequence of 3-phase of power source. The function will be available when user push *VAHz* key larger than one second. The initial range will be set to 200.0V range when phase-rotation mode is selected. Set COM terminal to the 1st voltage source and Vin terminal to the 2nd voltage source. The LOCK symbol of LCD segment starts blinking when ACV measurement is less than 80Vrms. When the AC voltage measurement is larger than 80Vrms (40 ~ 80Hz), the LOCK symbol will stop blinking and it means the 1st phase is locked. Then set Vin terminal to the 3rd voltage source within 5 seconds. If the AC voltage measurement is larger than 80Vrms (40 ~ 80Hz) again, the phase-rotation sequence will be determined and 1→2→3 or 3→2→1 symbols of LCD segment will be turn on to indicate the phase-rotation sequence. If the AC voltage is less than 80Vrms or signal frequency is not within 40~80Hz in 5 seconds duration, the phase-rotation detection will be aborted. Push *VAHz* key larger than one second will abort the detection also. The LOCK symbol will be disappeared when procedure is aborted.

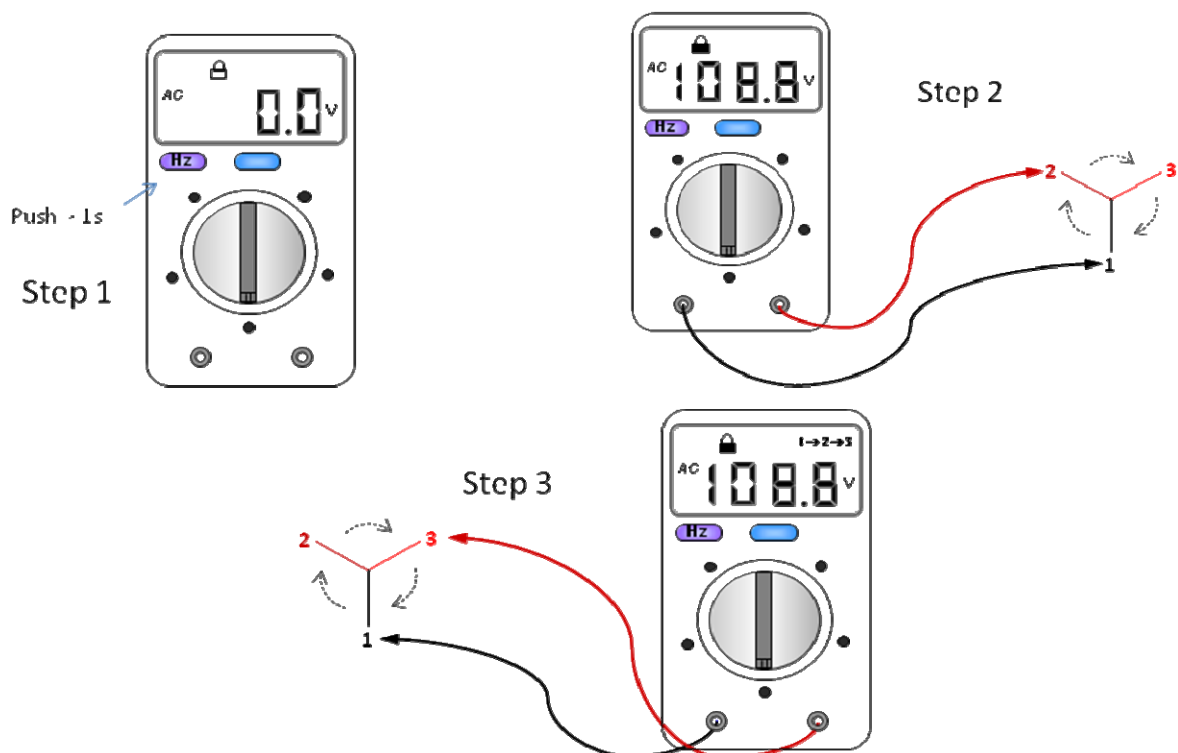

Note: The time limit is 5 seconds between Step2 & Step 3.



4. Serial Data Output

The RS232 function will be activated if press down the **HOLD** key and last for 2 seconds, RS232 symbol will be shown on the LCD display. The serial data sent to RSOUT pin periodically at every A/D conversion cycle by 3 times per second. The data format complies with 8Bits transmission code with a baud rate of 9600. The host can use RS232 interface to read the data. A single data packet includes a start bit (always 0), 8 data bits with no parity check bit, and a stop bit (always 1). The high and low voltage levels correspond to DGND and V- respectively. RSOUT remains at 1 (high) when it is inactive. Hence the start bit (0) could be used as the triggering signal to begin the reading process. The following figure shows the data format of a single packet.

Single packet

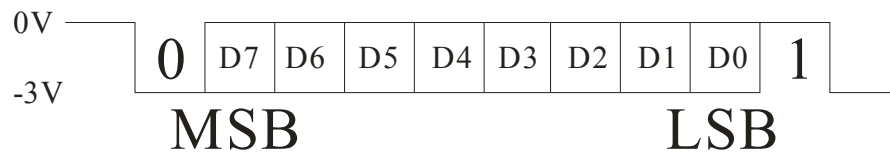

One data block consists of 17 packets. The following figure shows the format of a data block. The Header and Device code leads the whole packets. The range packet indicates the decimal point position on LCD panel of meter. Main_Digit1-3 consists of the readings on the LCD panel. The function packet indicates the measurement mode of the meter. Status1-4, Unit, Phase give the other status of the meter. CR and LF are delimiters used to separate the blocks.



All packets

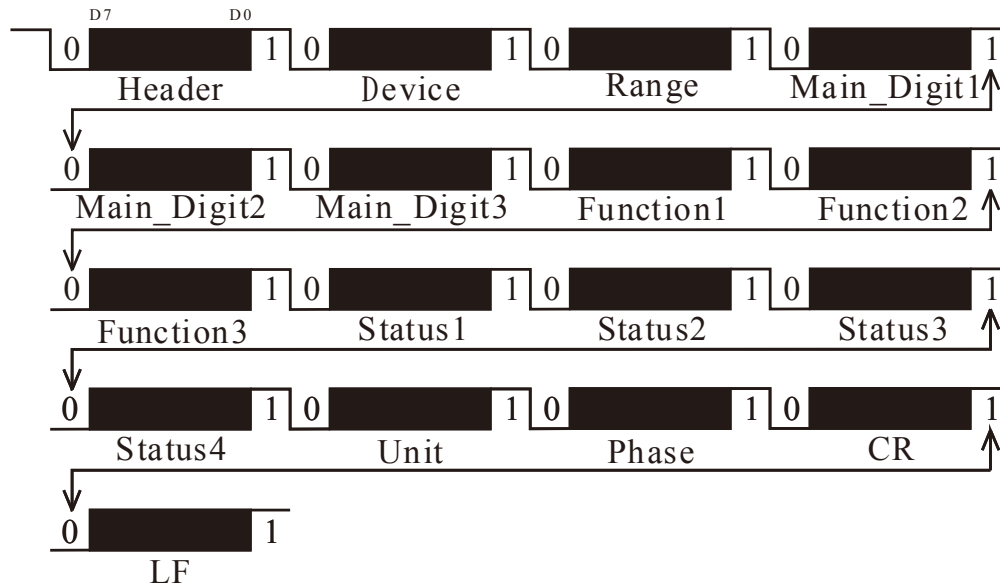

The meter always outputs the current value shown on LCD screen to the serial port. The detailed data format of each packet is listed below.

	D0	D1	D2	D3	D4	D5	D6	D7	
a01	0	0	0	0	1	1	1	1	Header
a02	1	0	0	0	0	0	1	1	Device
a03	X	X	X	X	DP1	DP2	DP3	X	Range
a04	M_SIGN	X	X	X	X	X	X	X	Main_Digit1
a05	Digit3 ₃	Digit3 ₂	Digit3 ₁	Digit3 ₀	Digit2 ₃	Digit2 ₂	Digit2 ₁	Digit2 ₀	Main_Digit2
a06	Digit1 ₃	Digit1 ₂	Digit1 ₁	Digit1 ₀	Digit0 ₃	Digit0 ₂	Digit0 ₁	Digit0 ₀	Main_Digit3
a07	V	A	Ohm	Continuity	Diode	Capacitance	Hz	X	Function1
a08	VAHZ	°C	°F	X	EFmode	X	Clamp	LED	Function2
a09	ADP0	ADP1	ADP2	ADP3	X	X	X	X	Function3
a10	AUTO	MANU	AC	DC	OL	X	X	X	Status1
a11	SLB1	SLB2	SLB3	LBAT30s	X	X	X	HOLD	Status2
a12	REL	ZERO	MAX	MIN	X	X	X	X	Status3
a13	Danger	X	X	DISCH	X	X	X	X	Status4
a14	Mega	Kilo	X	Mili	X	Micro	X	Nano	Unit
a15	X	PHSEQ	LOCK	3→2→1	1→2→3	Time_out	X	X	Phase
a16	0	0	0	0	1	1	0	1	CR
a17	0	0	0	0	1	0	1	0	LF

Note :

1. X → undefind.
2. Whole packet is shown by LSB first.



4.1. RANGE

This packet indicates range state of the meter. The DP1 – DP3 corresponding DP1 – DP3 of LCD segment (see section 5). In DCV 2.000V range, this **a03** packet will set **xxxx001x**. If change to 20.00V the packet will be **xxxx010x**.

	D0	D1	D2	D3	D4	D5	D6	D7
a03	X	X	X	X	DP1	DP2	DP3	X

4.2. Main_Digit1 –Main_Digit3

Main_Digit1 – Main_Digit3 is the readings of measurement result shown on LCD panel. DigitN₃ – DigitN₀ consist of 4-bit BCD code. The M_SIGN is the sign bit of readings.

	D0	D1	D2	D3	D4	D5	D6	D7
a04	M_SIGN	X	X	X	X	X	X	X
a05	Digit3 ₃	Digit3 ₂	Digit3 ₁	Digit3 ₀	Digit2 ₃	Digit2 ₂	Digit2 ₁	Digit2 ₀
a06	Digit1 ₃	Digit1 ₂	Digit1 ₁	Digit1 ₀	Digit0 ₃	Digit0 ₂	Digit0 ₁	Digit0 ₀

4.3. FUNCTION

The packets of **a07-a09** indicate the measurement mode of the meter. The following table summarizes the transmitted bit for each mode. Note that the encoding of this packet is different from the encoding of FC1-FC5 switch.

For example, if the meter operates in Voltage mode, this **a07** packet is **10000000**. If **VAHZ** key is pushed to VAHZ mode, the **a08** will be **10000000** also.

	D0	D1	D2	D3	D4	D5	D6	D7
a07	V	A	Ohm	Continuity	Diode	Capacitance	Hz	X
a08	VAHZ	°C	°F	X	EFmode	X	Clamp	LED
a09	ADP0	ADP1	ADP2	ADP3	X	X	X	X

4.4. STATUS

The a10-a13 packets indicate the whole status when ES252 is in normal operation. For example, if meter is operated at ACV / MANU range, then **a10** packet will set **011000xx**.

The format of the four packets are shown below.

	D0	D1	D2	D3	D4	D5	D6	D7
a10	AUTO	MANU	AC	DC	OL	X	X	X
a11	SLB1	SLB2	SLB3	LBAT30s	X	X	X	HOLD
a12	REL	ZERO	MAX	MIN	X	X	X	X
a13	Danger	X	X	DISCH	X	X	X	X



AUTO: When auto range is selected.

MANU: When manual mode is selected.

AC: When AC mode is selected.

DC: When DC mode is selected.

OL: When 'OL' is displayed on LCD.

SLB3/SLB2/SLB1: When low battery segment is shown on LCD.

LBAT30s: When 'Lobt' is shown on LCD.

HOLD: When Data HOLD mode is active.

REL: When Relative mode is active.

ZERO: When Zero function is active in DCA clamp mode.

MAX/MIN: When MAX/MIN mode is active.

Clamp: When clamp mode is selected. (Clamp pin is pulled to V-)

Danger: Abnormal applied voltage warning symbol is active on LCD.

DISC: The 'DisC' is shown on LCD. It means the DUT is necessary to be discharged on Cap mode.

4.5. Unit

This packet indicates the measurement unit of the LCD display.

	D0	D1	D2	D3	D4	D5	D6	D7
a14	Mega	Kilo	X	Mille	X	Micro	X	Nano

Mega = 1E6, Kilo=1E3, Mille=1E-3, Micro=1E-6, Nano=1E-9

4.6. Phase

The a15 packet is the status of phase-rotation function shown on LCD panel. When Phase-rotation function is active, the PHSEQ is set to 1. When the first target measurement is made, the LOCK status is set to 1 also. Then if the second target measurement is made, the phase-rotation check is finished. The 3→2→1 or 1→2→3 phase will be shown on LCD. If the second target could not be finished or the time period is larger than 5 seconds, the Time_out flag will be set to 1.

The format of this packet is shown below.

	D0	D1	D2	D3	D4	D5	D6	D7
a15	X	PHSEQ	LOCK	3→2→1	1→2→3	Time_out	X	X

4.7. CR

Carriage return: The transmitted code is **00001101**.

4.8. LF

Line feed: The transmitted code is **00001010**.



5. Miscellaneous

The conditions, which the meter turns on the buzzer, include:

- (1) Changing measurement mode generates one beep.
- (2) Pressing any of the push functions generates one beep, if the function is valid.
- (3) Power on and re-power on generate one beep.
- (4) Input overflow in voltage and current mode generates one beep every 0.3 seconds (or 3.33 beeps per second.)
- (5) Hazard voltage indication is active generates one beep per second and could be disabled by *DISDGB* pin.
- (6) Continuity(diode) check generates a continuous 2KHz beep whenever the measurement is less than $30\Omega(30mV)$
- (7) Auto power off generates a 2KHz beep sound that lasts for 1.5 seconds.

The following figures show the output waveform from the BUZOUT pin.

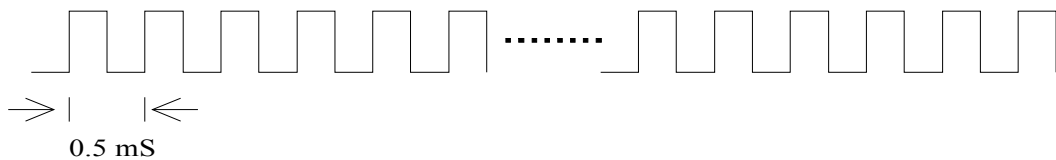

(a) Continuous 2KHz beep

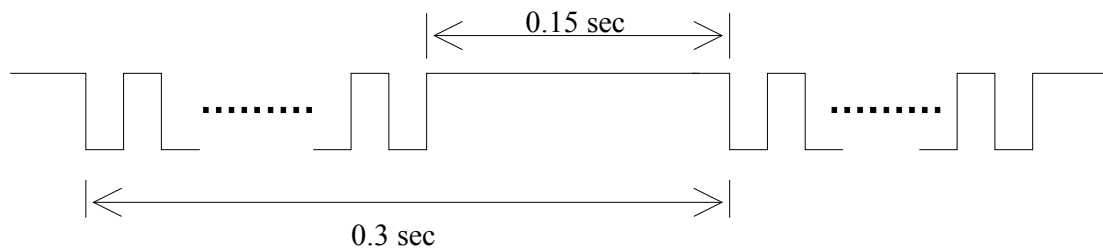

(b) 3.33 beep/sec



5.1. LCD Panel

	S01	S02	S03	S04	S05	S06	S07	S08	S09
BP1	SCAN	AUTO	4A	4B	3A	RS232	BUZZER	LED	DIODE
BP2	MANU	AC	4F	4G	3F	3B	2F	2A	2B
BP3	APO	MINUS	4E	4C	3E	3G	2E	2G	2C
BP4	DANGER	DC	4D	DP3	3D	3C	DP2	2D	DP1

	S10	S11	S12	S13	S14	S15	S16	S17	S18
BP1	1A	HOLD	REL	MAX	SLB1	$\mu 2$	M	n	Vin
BP2	1F	1B	LOCK	MIN	SLB2	m2	K	$\mu 1$	COM
BP3	1E	1G	321	$^{\circ}\text{C}$	SLB3	V	Ω	m1	mAin
BP4	1D	1C	123	$^{\circ}\text{F}$	ADP	A	Hz	F	Ain

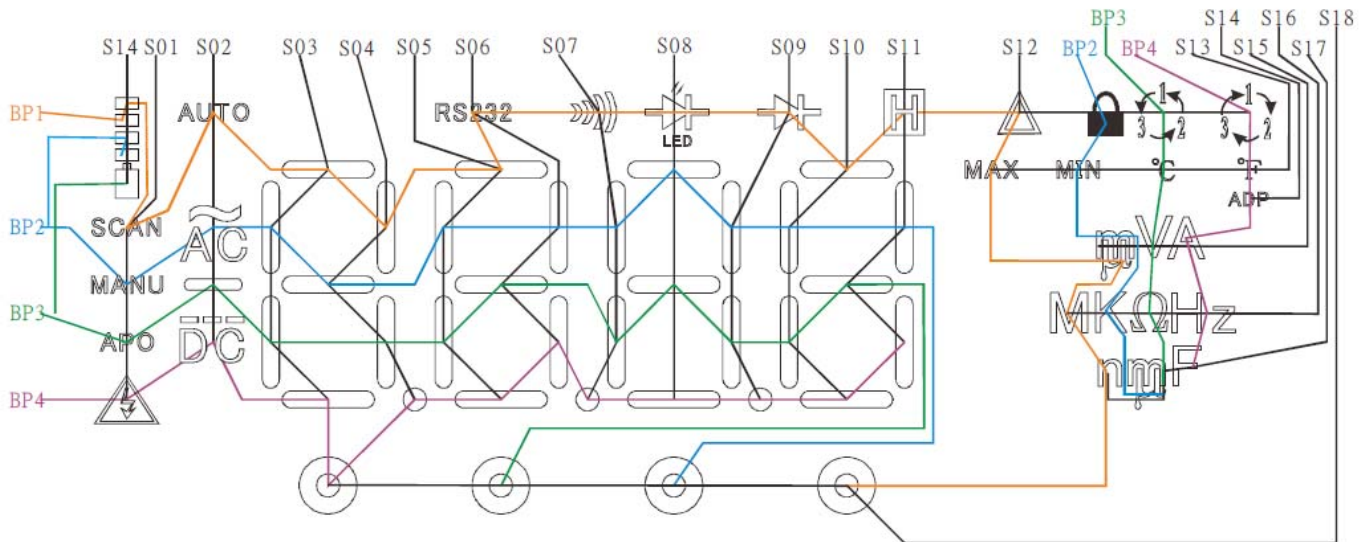

LCD Backplane Waveform

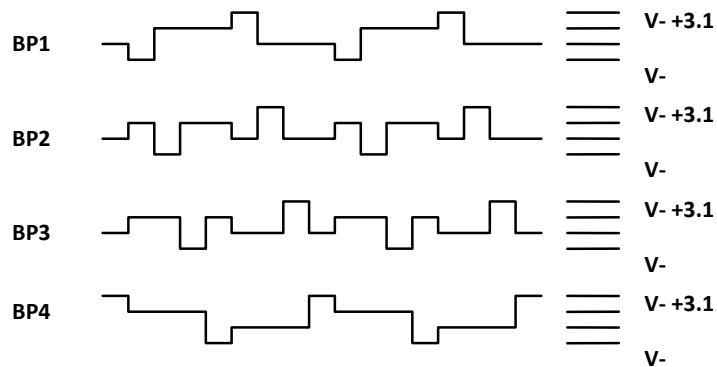



5.2. LCD Display On Condition

LCD Annunciator	Condition
V	In voltage measurement mode, and diode measurement mode.
A	In current measurement mode.
Ω	In resistance measurement mode, and continuity mode.
F	In capacitance measurement mode.
	In continuity check mode.
	In diode mode.
Hz	In frequency mode.
ADP	When ADP0-3 mode is active.
DC	In DC voltage or DC current mode.
AC	In AC voltage or AC current mode.
SCAN	When ACV/DCV scan mode is active
AUTO	When automatic full scale range selection is enabled.
MANU	In manual mode.
HOLD	When HOLD function is enabled.
	When Relative function is enabled.
MAX	When MAX function is enabled.
MIN	When MIN function is enabled.
m ₁	In capacitor measurement mode and the full scale range is in the order of mF.
μ ₁	In capacitor measurement mode and the full scale range is in the order of μ F.
n	In capacitor measurement mode and the full scale range is in the order of nF.
m ₂	In voltage or current measurement mode and the full scale range is in the order of 10^{-3} .
μ ₂	In current measurement mode and the full scale range is in the order of μ A.
M	In resistance measurement mode and the full scale range is in the order of M Ω .
K	In resistance measurement mode and the full scale range is in the order of K Ω .
$^{\circ}$ C	In temperature measurement mode and when the unit is $^{\circ}$ C.
$^{\circ}$ F	In temperature measurement mode and when the unit is $^{\circ}$ F.
	When the reading is exceeding default hazardous live voltage or OL in DCV or ACV, the HV warning symbol will be display. It will be active also when abnormal voltage applied at R/C/D/F modes.
APO	When auto power off function is enabled.
SLB1	When voltage (ref. to V-) of LBAT9 pin is less than Vt1, SLB1 will disappear.
SLB2	When voltage (ref. to V-) of LBAT9 pin is less than Vt2, SLB2 will disappear.
SLB3	When SLB2 disappears for 8 seconds, SLB3 will be blinking.
RS232	When RS232 output is enabled.
	When LED measurement function is enabled.
LOCK	When Phase-rotation mode is active, the LOCK symbol will be blinking. After the first target measurement is made successfully, the LOCK symbol will stop blinking.
123 or 321	When the second target measurement is finished, the phase rotation direction is confirmed.



5.3 Operating Timing

ES252 incorporates a dual slope ADC with four phases: ZI, AZ, INT and DINT. The timing of each phase is listed below.

- (1) Voltage / Diode /ADP / Manual Current (for clampmeter) measurement:

Phase	High resolution
ZI	50ms
AZ	25ms
INT	100ms
DINT	155ms

- (2) Current mode for multimeter/Auto Current mode for clampmeter/2-range auto voltage mode:

Phase	DC / AC	DC Lower Range
ZI	50ms	50ms
AZ	25ms	25ms
INT	100ms	1000ms
DINT	155ms	175ms

- (3) Continuity / Ohm measurement:

Phase	Time
ZI	50ms
AZ	100ms
INT	25ms*
DINT	155ms

Note: INT time = 250ms for 20.00Ω range

- (4) Frequency / VAHz measurement: Every conversion takes 1.05 second.
 (5) Temperature measurement: Every conversion takes 1.25 second.

Note:

- In the frequency measurement with auto mode, if the range is changed, the internal clock rate will increase ten times and the new measurement cycle becomes 1/10 times of the original cycle until the range is stable.



Application Circuit

1. AVG Circuit

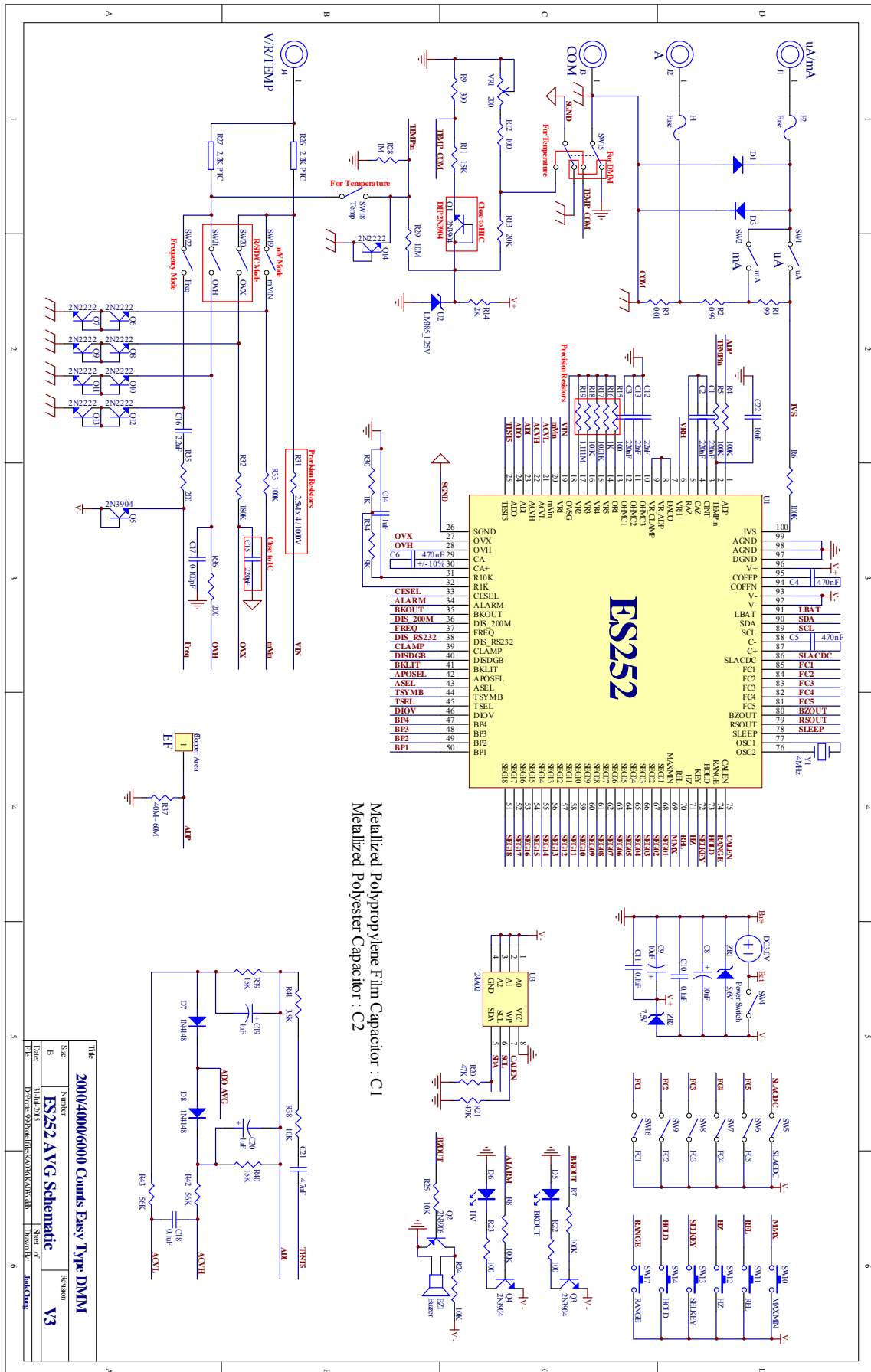



■ Package Information

1. 100L LQFP Outline drawing

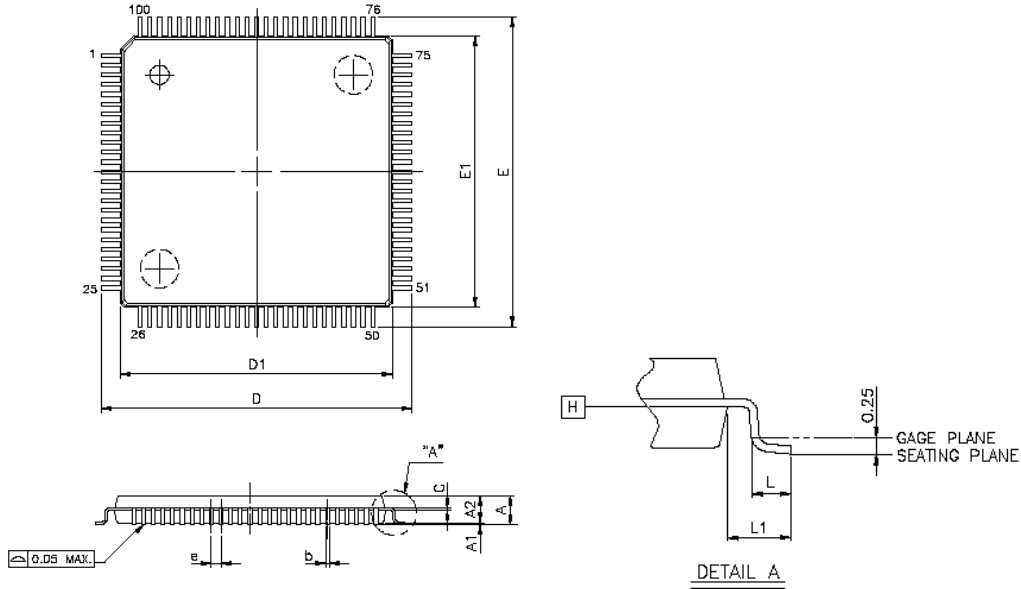

2. Dimension parameters

VARIATIONS (ALL DIMENSIONS SHOWN IN MM)

SYMBOLS	MIN.	NOM.	MAX.
A	--	--	1.60
A1	0.05	--	0.15
A2	1.35	1.40	1.45
b	0.17	0.20	0.27
c	0.09	0.127	0.20
D	16.00 BSC		
D1	14.00 BSC		
E	16.00 BSC		
E1	14.00 BSC		
e	0.50 BSC		
L	0.45	0.60	0.75
L1	1.00 REF		